







THE UK'S NO.1 POS DISPLAY SPECIALISTS



2022 DISPLAY TRENDS



## Why choose us?

-  25 million stocked items
-  Buy direct from the manufacturer
-  Next day delivery
-  Dedicated account manager
-  Highest quality products

Order by 5pm  
for next day delivery



**Telephone**  
0161 516 2467

**Email**  
sales@ukpos.com

**Online**  
www.ukpos.com



## 2022 Display Trends

We've handpicked a selection of our bestselling POS and new innovative products for this exclusive guide. We hope that this guide gives you inspiration for your displays and helps with a big boost in sales!

### Your proven partner

UK POS is a family-owned business built on knowledge, passion and the ambition to provide the best in the industry. With over 30 years' experience, we are a leading manufacturer and supplier of visual display products and are the first choice for over 500 global brands.

### Great value delivered tomorrow

Our extensive range of over 25 million stocked products available for next day delivery means we can meet the fast-changing needs of business. UK POS operates from state-of-the-art premises right here in the UK, we manage every step of the manufacturing process, giving you the highest quality at the lowest ever prices.

### Five star service

Our customers are at the heart of everything we do. We pride ourselves on providing great value, outstanding quality and a wide product range. Our customer service remains five star rated.

**Get ready to make  
your business visually  
outstanding in 2022!**

Jason Leslie and  
Debra Leslie Jamieson  
Founder and CEO,  
CSO.



## What's inside...

Sign, Print and Menu Holders	4
Ticket and Card Holders	24
Flexible Display Wallets	26
Shelf Edge Displays	28
Cable and Rod Displays	34
Wall Mount Panel Supports	38
Snap Frames and Pavement Signs	42
Digital Media	60
Chalkboards and Hospitality	64
Leaflet Dispensers	70
Suggestion and Ballot Boxes	76
Banner and Flag Stands	79
Barrier Systems	82
Showcard Stands	86
Dump Bins, Baskets and Display Stands	88
Merchandising and Displays	94
Merchandising Display Hooks and Accessories	107
Display Accessories and Fixings	112
Social Distancing and Hygiene	116





## AS1 ACRYLIC FREESTANDING POSTER HOLDER



- Slanted poster display for countertops
- Make your product, promotion or service stand out
- Designed with a side opening for simple updates
- Manufactured from 2mm and 3mm clear acrylic

FROM  
**£0.49**

## Portrait

Size	Code	1+	25+	100+	500+
A9	AS1A9	£0.59	£0.55	£0.52	£0.49
A8	AS1A8	£0.80	£0.72	£0.62	£0.54
A7	AS1A7	£1.00	£0.89	£0.84	£0.72
A6	AS1A6	£1.27	£1.09	£1.01	£0.99
1/3 A4 (third A4)	AS11/3A4	£1.86	£1.74	£1.55	£1.34
A5	AS1A5	£2.10	£1.77	£1.65	£1.56
A4	AS1A4	£2.91	£2.63	£2.35	£2.33
A3	AS1A3	£8.97	£7.85	£7.37	£7.07

PRICE EACH – Other sizes manufactured on request.

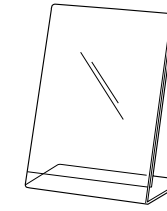

Portrait



## Landscape

Size	Code	1+	25+	100+	500+
A9	AS2A9	£0.59	£0.55	£0.52	£0.49
A8	AS2A8	£0.80	£0.72	£0.59	£0.51
A7	AS2A7	£1.00	£0.89	£0.82	£0.71
A6	AS2A6	£1.27	£1.09	£1.01	£0.99
A5	AS2A5	£2.15	£1.82	£1.72	£1.65
A4	AS2A4	£3.32	£3.27	£3.09	£2.74
A3	AS2A3	£7.25	£6.83	£6.23	£5.81

PRICE EACH – Other sizes manufactured on request.

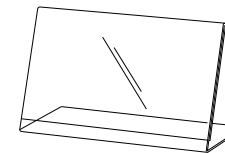

Landscape

**BRAND**  
your product

## STY1/STY6 BUDGET POSTER HOLDER

## BUDGET

- Budget poster display suitable for any industry
- Easy-access side opening for simple updates
- Designed on an angle for optimum customer viewing
- Manufactured from 1.6mm styrene

## STY1 – portrait

Size	Code	1+	25+	100+	500+
A9	STY1A9	£0.54	£0.43	£0.37	£0.32
A8	STY1A8	£0.57	£0.46	£0.40	£0.35
A7	STY1A7	£0.64	£0.51	£0.44	£0.42
A6	STY1A6	£0.95	£0.83	£0.71	£0.63
A5	STY1A5	£1.27	£1.20	£1.04	£0.90
A4	STY1A4	£2.24	£1.97	£1.70	£1.48

PRICE EACH – Other sizes manufactured on request.

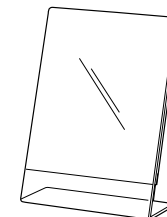

STY1 – portrait

## STY6 – landscape

Size	Code	1+	25+	100+	500+
A9	STY6A9	£0.57	£0.45	£0.38	£0.33
A8	STY6A8	£0.60	£0.48	£0.41	£0.36
A7	STY6A7	£0.66	£0.52	£0.49	£0.47
A6	STY6A6	£0.95	£0.83	£0.72	£0.64
A5	STY6A5	£1.29	£1.20	£1.05	£0.90
A4	STY6A4	£2.34	£2.06	£1.77	£1.73

PRICE EACH – Other sizes manufactured on request.

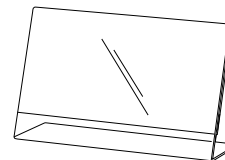

STY6 – landscape





### AD5 ACRYLIC SHOWCARD PHOTO HOLDER



Portrait or landscape

- An elegant and modern holder that frames your photo
- A5 and A4 sizes available
- Can be used in portrait or landscape format
- Supplied with chrome supports and screws
- Manufactured from 2 x 3mm acrylic panels

Size	Code	1+	25+	100+	250+
A5	AD5A5	£10.37	£8.87	£8.28	£8.19
A4	AD5A4	£13.49	£11.84	£11.47	£10.81

PRICE EACH – Other sizes manufactured on request.

### PS7 PVC FREESTANDING POSTER HOLDER

BUDGET



- Freestanding poster holder ideal for any industry
- Designed to display at an angle for optimum viewing
- Side opening allows for easy changeovers
- Manufactured from 900 micron clear PVC

Size	Code	1+	25+	100+	500+
A6	PS7A6	£0.84	£0.71	£0.67	£0.63
A5	PS7A5	£1.24	£1.10	£0.93	£0.84

PRICE EACH – Other sizes manufactured on request.

### US1P UNBREAKABLE FREESTANDING POSTER HOLDER

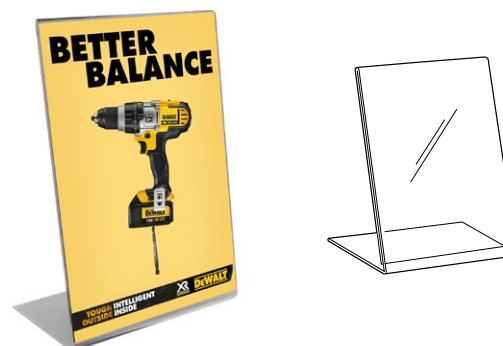

- Slanted, single-sided portrait poster display for countertops
- Manufactured from 'virtually unbreakable' 2mm clear PETG
- Make your product, promotion or service stand out
- Designed with a side opening for simple updates

Size	Code	1+	25+	100+	500+
A6	US1A6	£1.81	£1.59	£1.39	£1.31
A5	US1A5	£2.55	£2.35	£2.17	£2.09
A4	US1A4	£3.74	£3.55	£3.38	£3.27

PRICE EACH – Other sizes manufactured on request.

UNBREAKABLE

### AS8 ACRYLIC BED POSTER HOLDER



FROM  
**£5.53**

- Bed poster holder to help promote your offers
- Base fits securely under mattresses up to 22cm thick
- Manufactured using 2mm clear acrylic
- Central panel: 230mm H
- Total size of A4 poster holder (W x H x D): 220mm x 304mm x 270mm
- Total size of A5 poster holder (W x H x D): 150mm x 270mm x 270mm

Size	Code	1+	25+	100+	500+
A5	AS8A5	£7.37	£6.89	£6.34	£5.53
A4	AS8A4	£9.38	£8.59	£8.16	£7.53

PRICE EACH – Other sizes manufactured on request.

### SD4 A4 POSTER HOLDER WITH LEAFLET DISPENSER



- Versatile countertop A4 poster display which can also hold literature
- Choose between a dispenser that can hold both 1/3 A4 and A6 leaflets, or one that can hold A5 leaflets
- Manufactured from 2mm or 3mm clear acrylic
- Portrait poster holder size: 210mm W x 297mm H

Pocket size	Code	1+	25+	100+
1/3 A4 (third A4) OR A6	SD4	£5.90	£5.46	£4.95
A5	SD45	£9.42	£8.94	£8.06

PRICE EACH – Other sizes manufactured on request.



### SD4B POSTER HOLDER WITH BUSINESS CARD POCKET

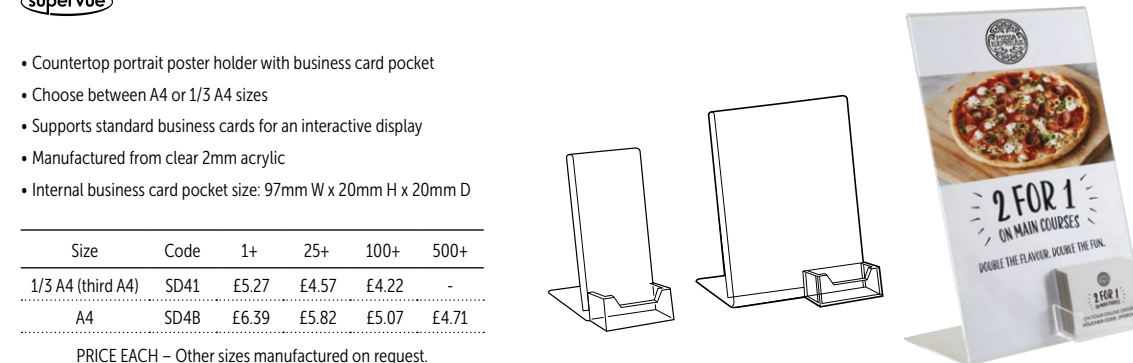

- Countertop portrait poster holder with business card pocket
- Choose between A4 or 1/3 A4 sizes
- Supports standard business cards for an interactive display
- Manufactured from clear 2mm acrylic
- Internal business card pocket size: 97mm W x 20mm H x 20mm D

Size	Code	1+	25+	100+	500+
1/3 A4 (third A4)	SD41	£5.27	£4.57	£4.22	-
A4	SD4B	£6.39	£5.82	£5.07	£4.71

PRICE EACH – Other sizes manufactured on request.

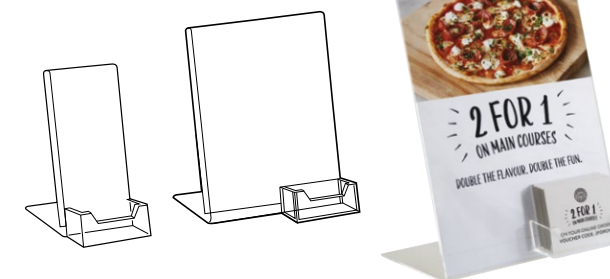





**TMH WOODEN A FRAME CLIPBOARD MENU HOLDER**



- Wooden clipboard menu holder for A4, A5 and A6 graphics
- Secure your poster in place with the fixed metal clip
- Add a rustic feel to your retail window display, bar top or dining area
- Provides a high-impact single-sided POS display
- Manufactured from 4mm thick veneered wood
- Overall size (A4): 235mm W x 345mm H x 75mm D
- Overall size (A5): 165mm W x 260mm H x 65mm D
- Overall size (A6): 140mm W x 190mm H x 50mm D

Size	Colour	Code	Price
A6	Natural	TMH01A6	£7.90
A5	Natural	TMH01A5	£10.35
A4	Natural	TMH01A4	£14.75
A5	Dark Oak	TMH02A5	£11.94
A4	Dark Oak	TMH02A4	£14.96

PRICE EACH

**CMBC WOODEN MENU DISPLAY STAND WITH BULLDOG CLIP**



- Traditional-style standing wooden menu and sign holder
- Easily and quickly secure your display with the attached 5cm metal bulldog clip
- Instant assembly and easy to dismantle or relocate
- Overall size (A4): 334mm W x 225mm H
- Overall size (A5): 245mm W x 164mm H

Size	Code	Price
A5	CMBCA5	£12.04
A4	CMBCA4	£14.35

PRICE EACH

**WMBC WOODEN MENU HOLDER WITH CLIP**



- Versatile wooden sign holder for posters and graphics
- Available in A4 and A5 sizes
- Secure your poster in place with the stylish spring clip
- Add a rustic feel to your retail window display, bar top or dining area
- Angled design for easy viewing
- Provides a high-impact single-sided POS display
- Manufactured from birch plywood
- Overall size (A4): 225mm W x 327mm H x 88mm D
- Overall size (A5): 165mm W x 236mm H x 88mm D

Size	Code	1+	10+
A5	WMBCA5	£8.70	£7.10
A4	WMBCA4	£9.43	£7.89

PRICE EACH – Other sizes manufactured on request.



**WMBCO DARK OAK WOODEN MENU HOLDER WITH METAL CLIP**

- Vintage dark oak wooden menu holder for A3, A4 and A5 graphics
- Secure your poster in place with the stylish metal clip
- Add a rustic feel to your retail window display, bar top or dining area
- Angled design for easy viewing
- Provides a high-impact single-sided POS display
- Manufactured from 5mm thick wood with a dark oak veneer

Size	Code	Price
A5	WMBCOA5	£9.60
A4	WMBCOA4	£13.14
A3	WMBCOA3	£16.10

PRICE EACH – Other sizes manufactured on request.





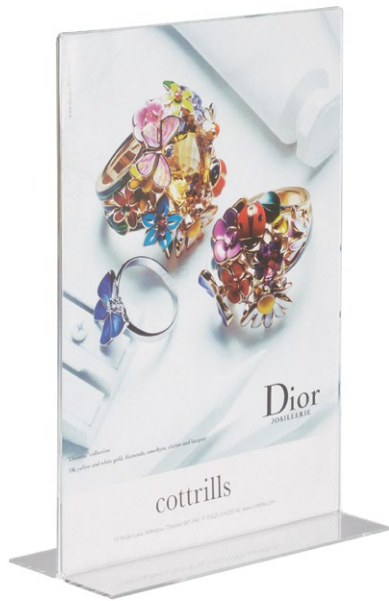

## AD3/AD4 ACRYLIC POSTER HOLDER WITH OPEN BASE

- Double-sided poster display for countertops
- Designed with an easy-access open base
- Manufactured from 2mm clear acrylic

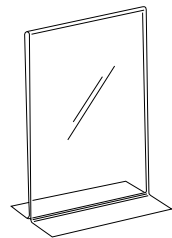

AD3 – portrait

## AD3 – portrait

Size	Code	1+	25+	100+	500+
A7	AD3A7	£1.15	£0.98	£0.89	£0.80
A6	AD3A6	£1.47	£1.33	£1.17	£1.05
1/3 A4 (third A4)	AD31/3A4	£2.19	£1.87	£1.56	£1.39
A5	AD3A5	£2.04	£1.92	£1.69	£1.59
A4	AD3A4	£3.54	£3.08	£2.84	£2.69

PRICE EACH – Other sizes manufactured on request.

## AD4 – landscape

Size	Code	1+	25+	100+	500+
A7	AD4A7	£1.21	£1.10	£1.05	£1.01
A6	AD4A6	£1.55	£1.41	£1.26	£1.12
A5	AD4A5	£2.22	£2.07	£1.79	£1.69
A4	AD4A4	£3.86	£3.27	£3.09	£3.03
A3	AD4A3	£9.30	£8.18	£7.28	£7.12

PRICE EACH – Other sizes manufactured on request.

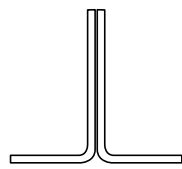

Open base

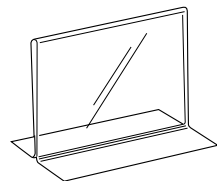

AD4 – landscape

## STY2/STY3 BUDGET DOUBLE SIDED POSTER HOLDER

BUDGET

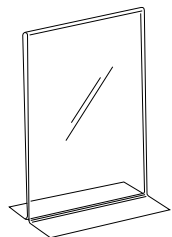

STY2 – portrait

- Double-sided countertop poster display
- Designed with an easy-access side opening
- Manufactured from clear 1.6mm styrene

## STY2 – portrait

Size	Code	1+	25+	100+	500+
A7	STY2A7	£0.72	£0.58	£0.51	£0.49
A6	STY2A6	£1.15	£0.92	£0.71	£0.69
A5	STY2A5	£1.61	£1.33	£1.15	£1.13
A4	STY2A4	£2.96	£2.80	£2.38	£2.09

PRICE EACH

## STY3 – landscape

Size	Code	1+	25+	100+	500+
A7	STY3A7	£0.72	£0.58	£0.51	£0.49
A6	STY3A6	£1.21	£1.01	£0.83	£0.77
A5	STY3A5	£1.66	£1.40	£1.24	£1.20
A4	STY3A4	£3.02	£2.80	£2.38	£2.19

PRICE EACH

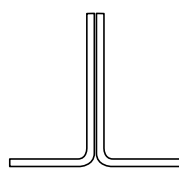

Open base

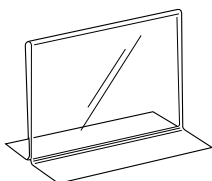

STY3 – landscape



## AD1 ACRYLIC POSTER HOLDER WITH CLOSED BASE

- Double-sided countertop poster display
- Promote your business, prices and product specs
- Designed with an easy-access side opening
- Manufactured from 2mm or 3mm clear acrylic

FROM  
£0.89

## Portrait

Size	Code	1+	25+	100+	500+
A7	AD1A7	£1.28	£1.10	£1.00	£0.89
A6	AD1A6	£1.64	£1.48	£1.31	£1.17
1/3 A4 (third A4)	AD11/3A4	£2.19	£1.87	£1.56	£1.39
A5	AD1A5	£2.27	£2.14	£1.88	£1.77
A4	AD1A4	£3.54	£3.15	£2.95	£2.82
A3	AD1A3	£10.10	£9.45	£8.59	£8.30

PRICE EACH – Other sizes manufactured on request.

## Landscape

Size	Code	1+	25+	100+	500+
A7	AD2A7	£1.35	£1.23	£1.17	£1.13
A6	AD2A6	£1.72	£1.57	£1.40	£1.25
A5	AD2A5	£2.47	£2.31	£2.00	£1.88
A4	AD2A4	£3.86	£3.48	£3.27	£3.23
A3	AD2A3	£10.33	£9.09	£8.08	£7.91

PRICE EACH – Other sizes manufactured on request.

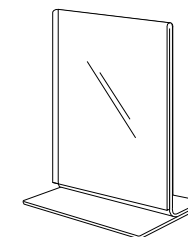

Portrait

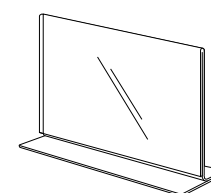

Landscape

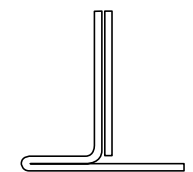

Closed base





### ADF COUNTER STANDING ACRYLIC BLOCK SIGN HOLDER

superVue



- Black or white base counterstanding poster display for quick and regular graphic updates
- Slide your posters in between the clear panels for a double-sided display
- Upright manufactured using two 3mm clear acrylic panels
- Base manufactured from 10mm acrylic

#### Black

Size	Code	1+	25+	100+
A6	ADFKA6	£10.40	£8.76	£8.08
A5	ADFKA5	£11.59	£9.77	£9.33
A4	ADFKA4	£16.49	£13.73	£13.01

PRICE EACH – Other sizes, thicknesses and colours available on request.

#### White

Size	Code	1+	25+	100+
A5	ADFWA5	£11.59	£9.77	£9.33
A4	ADFWA4	£16.49	£13.73	£13.01

PRICE EACH – Other sizes, thicknesses and colours available on request.

### ADP1 PREMIUM ACRYLIC POSTER DISPLAY BLOCK

superVue



- Luxury diamond-polished acrylic block display
- Perfect for high-end retail displays
- Create high-impact double-sided advertising
- Upright manufactured from two 5mm clear acrylic panels
- Base manufactured from 10mm clear acrylic

Size	Code	1+	25+	100+
A6	ADP1A6	£10.66	£9.04	£8.44
A5	ADP1A5	£12.92	£11.09	£10.03
A4	ADP1A4	£17.69	£15.27	£14.00

PRICE EACH – Other sizes manufactured on request.



### AD7 MAGNETIC PHOTO BLOCK

superVue

- Create a stylish double-sided countertop display
- Print is securely held in place with mini magnets
- A6, A5 and A4 sizes all have four magnets, one in each corner
- 90mm x 60mm and A7 sizes have two magnets
- Can be used in portrait or landscape format
- Manufactured from high-quality clear acrylic
- The 90 x 60mm size has two 6mm panels, A7-A5 sizes have two 10mm acrylic panels, and the A4 size has two 15mm acrylic panels

Size	Code	1+	25+	100+
90mm x 60mm	AD7B	£4.07	£3.52	£3.21
A7	AD7A7	£6.88	£5.77	£5.38
A6	AD7A6	£7.55	£6.56	£6.18
A5	AD7A5	£10.32	£9.74	£9.38
A4	AD7A4	£31.00	£28.16	£26.91

PRICE EACH – Other sizes manufactured on request.



FROM  
£3.21

## Bring your brand to life

Work with our expert design team to create a personalised branded block in any shape, style or size to help boost your brand recognition. Visit [www.ukpos.com](http://www.ukpos.com) to design your branded block today.

To speak to our sales team CALL 0161 516 2467

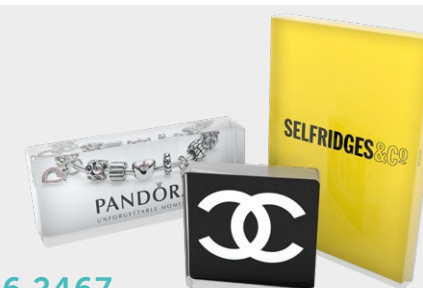



### AD13 MAGNETIC CLEAR ACRYLIC BLOCK SIGN HOLDER

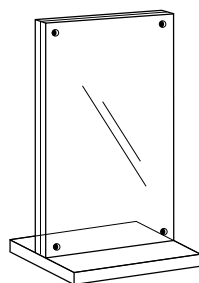

- Cost-effective way of creating a double-sided display on your countertops
- Your graphics slot in between two magnetic acrylic panels for quick updates
- Upright manufactured from two 3mm clear acrylic panels
- Base manufactured from 10mm clear acrylic
- Overall size (A4): 240mm W x 340mm H
- Overall size (A5): 180mm W x 250mm H
- Overall size (A6): 135mm W x 187mm H

Size	Code	1+	25+	100+
A6	AD13A6	£7.72	£7.25	£6.90
A5	AD13A5	£10.57	£10.01	£9.40
A4	AD13A4	£15.38	£13.97	£13.19

PRICE EACH – Other sizes manufactured on request.

### AD12 CLEAR MAGNETIC ACRYLIC BLOCK SIGN HOLDER

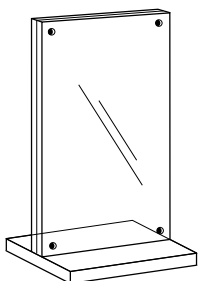

- Modern luxury POS display accessory for displaying A5 or A4 graphics
- Graphics slide between the two panels for easy updates
- Creates a standout double-sided display
- A5 size manufactured from 10mm clear acrylic
- A4 size manufactured from 15mm clear acrylic
- Base size (A4): 212mm W x 19mm H x 100mm D
- Base size (A5): 150mm W x 12mm H x 60mm D

Size	Code	1+	25+	100+
A5	AD12A5	£18.84	£18.23	£16.94
A4	AD12A4	£37.45	£35.47	£33.67

PRICE EACH – Other sizes manufactured on request.

### AD8 OVAL BASE ACRYLIC POSTER HOLDER

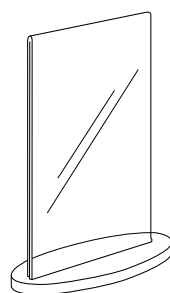

FROM  
**£3.99**

- Counter standing, double-sided poster display with a stylish oval base
- Available in A5 and A4 sizes
- Header and base slot together easily for interchangeable messages
- Manufactured from 2mm clear acrylic with a substantial 5mm base

Size	Code	1+	25+	100+	250+
A5	AD8A5	£5.15	£4.74	£4.49	£3.99
A4	AD8A4	£8.54	£7.90	£7.32	£7.02

PRICE EACH – Other sizes, thicknesses and colours available on request.



### MTS DOUBLE SIDED METAL TABLE SIGN HOLDER

NEW

- Double Sided Metal Table Sign Holder in A3 or A4 sizes
- Heavy-duty metal frames for a modern finish
- Compatible with 3mm Foamex signs
- Available with a choice of adding single or double-sided Foamex prints
- Freestanding or screw into a countertop for a more secure display
- Fixings supplied
- A3 size: 303mm W x 423mm H
- A4 size: 217mm W x 310mm H

Size	With print	Code	1+	5+
A4	No	MTSA4	£10.87	£9.98
A3	No	MTSA3	£13.97	£12.78
A4	Single sided	MTSA4-S-PRINTED	£19.25	£17.68
A3	Single sided	MTSA3-S-PRINTED	£24.95	£22.87
A4	Double sided	MTSA4-D-PRINTED	£22.22	£21.41
A3	Double sided	MTSA3-D-PRINTED	£27.96	£26.91

PRICE EACH – Other sizes manufactured on request.



## Complete your POS display

We boast an extensive in-house printing service which allows you to order the full POS package in one easy transaction.

For more information **CALL 0161 516 2467**







### DMH DUO WOODEN TABLE MENU HOLDER

NEW



- Wooden Menu Holder with space to display a poster and menu simultaneously
- The rustic design is ideal for use in cafes and restaurants
- Made from lightweight, dark beech wood with a lacquered finish
- Add a plain chalkboard or clear PET pocket insert if required
- Groove slot width: 4.5mm
- Total size of A5 holder: 220mm W x 180mm H x 85mm D
- Total size of A4 holder: 287mm W x 250mm H x 85mm D

Size	With insert	Code	1+	10+
A5	No	DMHA5	£9.95	£9.60
A4	No	DMHA4	£10.70	£10.30
A5	Chalkboard insert	DMHA5-CHLK	£11.19	£10.70
A4	Chalkboard insert	DMHA4-CHLK	£12.93	£12.35
A5	PET insert	DMHA5-PET	£12.05	£11.45
A4	PET insert	DMHA4-PET	£13.66	£13.04

PRICE EACH – Other sizes manufactured on request.

### CMSH CURVED WOODEN MENU SIGN HOLDER

NEW



- Curved Wooden Menu Sign Holder to display menus and posters
- Made from dark beech plywood with a lacquered finish
- Perfect for use in restaurants, hospitality and retail
- Resistant to food and drink spillages
- A4 overall size: 288mm W x 318mm H x 60mm D
- A5 overall size: 220mm W x 225mm H x 60mm D

Size	Code	1+	10+
A5	CMSHA5	£10.40	£9.80
A4	CMSHA4	£11.80	£11.40

PRICE EACH – Other sizes manufactured on request.

### AS11 MENU HOLDER WITH THREE FACES

supervue



- Three-sided portrait menu holder ideal for bars or restaurants
- Display your food, drink and event promotions in one unit
- Can display three separate posters at once
- Manufactured from high-impact 2mm acrylic

Face size	Code	1+	25+	100+	500+
A6	AS11A6	£5.36	£4.87	£4.71	£4.48
1/3 A4 (third A4)	AS111/3A4	£5.57	£4.95	£4.88	£4.69
A5	AS11A5	£8.04	£7.07	£6.23	£6.06

PRICE EACH – Other sizes manufactured on request.



FROM  
£4.48

### AS3 ACRYLIC MENU HOLDER WITH SIX FACES

supervue

- Six-sided menu holder ideal for a range of graphic designs
- Perfect for displaying multiple offers or messages in one
- Manufactured from 2mm clear acrylic

Face size	Code	1+	25+	100+	500+
A6	AS3A6	£4.13	£3.88	£3.43	£3.25
1/3 A4 (third A4)	AS31/3A4	£4.69	£4.35	£3.94	£3.50
A5	AS3A5	£6.81	£6.34	£5.81	£5.22

PRICE EACH – Other sizes manufactured on request.

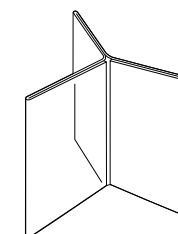

FROM  
£3.25





### CWB WOODEN CARD HOLDER BASE



- Dark wooden display block with a 3mm wide and 20mm deep groove
- Ideal for menus, signs or table numbers
- Manufactured from pine wood
- Available in three widths: 105mm, 148mm and 210mm
- Base size: 40mm H x 40mm D

Size (mm)	Code	1+	10+
A6P (105 W)	CWB-1	£4.17	£3.97
A5P (148 W)	CWB-2	£4.59	£4.37
A4P (210 W)	CWB-3	£5.15	£4.95

PRICE EACH – Other sizes/finishes manufactured on request.

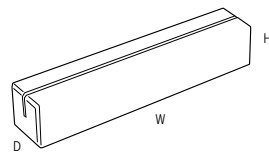

### PS5 BUDGET TENT CARD HOLDER

#### BUDGET



- Counter standing double-sided tent style display
- A8 - A5 sizes available
- Ideal for a variety of tickets or cards
- Manufactured from 700 micron clear PVC

Size	Code	1+	25+	100+	500+
A8	PSS-1	£1.15	£0.93	£0.74	£0.54
A7	PSS-2	£1.28	£1.01	£0.83	£0.63
1/3 A4 (third A4)	PSS-6	£1.45	£1.27	£1.15	£1.05
A5	PSS-7	£1.93	£1.62	£1.49	£1.35

PRICE EACH – Other sizes manufactured on request.

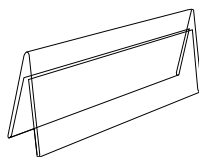

### AS6 ACRYLIC TENT CARD HOLDER



- Double-sided tent style card holder for countertops
- Ideal for displaying place settings, table numbers and more
- Manufactured from 2mm clear acrylic

FROM  
**£0.94**

Size	Code	1+	25+	100+	500+
A8 landscape	AS6-1	£1.36	£1.05	£0.98	£0.94
A7 landscape	AS6-2	£1.79	£1.44	£1.34	£1.28
A6 landscape	AS6-3	£2.56	£2.14	£1.92	£1.64
1/3 A4 (third A4) landscape	AS6-4	£3.15	£2.68	£2.33	£2.11
A5 landscape	AS6-5	£3.47	£3.08	£2.80	£2.62

PRICE EACH – Other sizes manufactured on request.

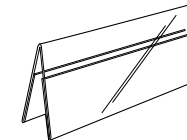

### AS4 ACRYLIC SHOWCARD HOLDER BASE



- Ideal for displaying printed show cards
- Available in three sizes to suit A8, A7 or A6 graphics
- Display on countertops around your business
- Manufactured from high-impact 2mm clear acrylic

Size (mm)	Code	1+	25+	100+	500+
50 W x 75 D	AS4-50	£1.53	£1.31	£1.13	£1.10
100 W x 75 D	AS4-100	£1.93	£1.80	£1.66	£1.59
150 W x 75 D	AS4-150	£2.21	£2.07	£1.96	£1.89

PRICE EACH – Other sizes manufactured on request.

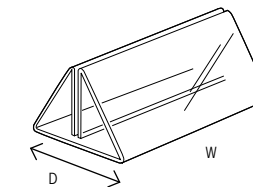

**BRAND**  
your product

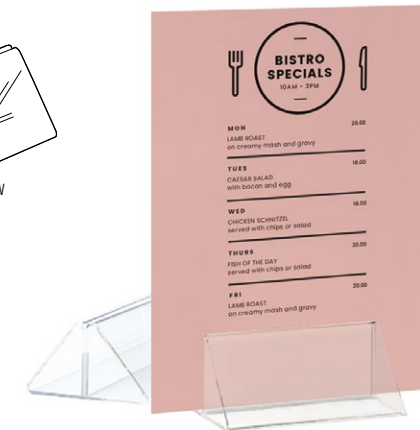

### AS12 ACRYLIC TENT SHOWCARD HOLDER



- Ideal for displaying printed showcards or menus
- Choose between 50mm, 100mm and 150mm widths
- Display on countertops or tables in your business
- Manufactured from 2mm clear acrylic
- Maximum insert thickness of 2mm
- Height of 40mm

Size (mm)	Code	1+	25+	100+	500+
50 W x 75 D	AS12-50	£1.17	£1.11	£1.05	£0.98
100 W x 75 D	AS12-100	£1.65	£1.44	£1.35	£1.25
150 W x 75 D	AS12-150	£1.81	£1.56	£1.46	£1.39

PRICE EACH – Other sizes manufactured on request.

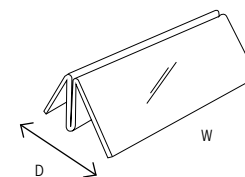



WPHN ACRYLIC POSTER HOLDER WITH HOLES



- Wall-mounted poster holder with 5mm fixing holes
- Designed for easy and quick graphic updates
- Manufactured from 2mm clear acrylic
- Fixings not included

Portrait

Size	Code	1+	25+	100+	500+
A5	WPHN1A5	£2.11	£1.97	£1.85	£1.77
A4	WPHN1A4	£3.33	£3.21	£2.80	£2.74
A3	WPHN1A3	£6.83	£6.14	£5.81	£5.57

PRICE EACH – Other sizes manufactured on request.

Landscape

Size	Code	1+	25+	100+	500+
A5	WPHN2A5	£2.30	£2.22	£2.06	£1.91
A4	WPHN2A4	£3.42	£3.26	£2.88	£2.80
A3	WPHN2A3	£7.28	£6.40	£5.91	£5.67

PRICE EACH – Other sizes manufactured on request.



PS4P/PS4L ADHESIVE TICKET HOLDER



- Interchangeable promotional ticket holder
- Designed with adhesive tape applied to back returns
- Manufactured from 480 micron clear PVC

PS4P – portrait

Size	Code	1+	25+	100+	500+
A7	PS4A7P	£0.73	£0.62	£0.50	£0.40
A6	PS4A6P	£0.80	£0.69	£0.53	£0.41
A5	PS4A5P	£0.82	£0.68	£0.58	£0.45
A4	PS4A4P	£1.17	£0.85	£0.64	£0.50
A3	PS4A3P	£2.35	£2.02	£1.88	£1.55

PRICE EACH – Other sizes manufactured on request.

PS4L – landscape

Size	Code	1+	25+	100+	500+
A7	PS4A7L	£0.79	£0.66	£0.54	£0.43
A6	PS4A6L	£0.81	£0.70	£0.59	£0.50
A5	PS4A5L	£1.10	£0.72	£0.63	£0.57
A4	PS4A4L	£1.43	£1.05	£0.75	£0.63
A3	PS4A3L	£2.56	£2.11	£1.94	£1.72

PRICE EACH – Other sizes manufactured on request.

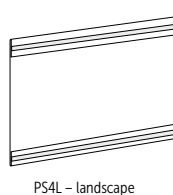
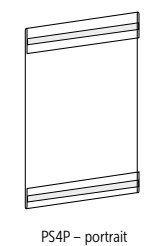

AS5 ACRYLIC POSTER SLEEVE



Portrait

Size	Code	1+	25+	100+	500+
A8	ASSA8P	£0.82	£0.74	£0.68	£0.66
A7	ASSA7P	£0.94	£0.84	£0.78	£0.74
A6	ASSA6P	£1.29	£1.11	£1.01	£0.94
1/3 A4 (third A4)	ASS1/3A4P	£1.74	£1.56	£1.42	£1.35
A5	ASSA5P	£1.97	£1.60	£1.49	£1.44
A4	ASSA4P	£2.99	£2.86	£2.50	£2.36
A3	ASSA3P	£5.88	£5.54	£5.43	£4.74
A2	ASSA2P	£18.72	£17.68	£16.07	£14.65
A1	ASSA1P	£39.75	£35.07	£31.51	£31.00

PRICE EACH – Other sizes manufactured on request.

Landscape

Size	Code	1+	25+	100+	500+
A8	ASSA8L	£0.89	£0.79	£0.71	£0.68
A7	ASSA7L	£0.96	£0.85	£0.79	£0.77
A6	ASSA6L	£1.36	£1.21	£1.15	£1.11
1/3 A4 (third A4)	ASS1/3A4L	£1.77	£1.60	£1.45	£1.39
A5	ASSA5L	£2.01	£1.65	£1.54	£1.48
A4	ASSA4L	£3.08	£2.94	£2.55	£2.46
A3	ASSA3L	£6.43	£6.06	£5.55	£4.83
A2	ASSA2L	£19.91	£19.35	£18.23	£17.55
A1	ASSA1L	£41.69	£36.77	£34.95	£33.77

PRICE EACH – Other sizes manufactured on request.



FROM **£0.66**

- A simple way to display posters on walls around your business
- Easy-access side opening allows for quick and easy updates
- Manufactured from high-quality 2 - 3mm clear acrylic
- Available with optional adhesive foam pads for easy mounting

With adhesive foam pads (portrait)

Size	Code	1+	25+	100+	500+
A5	ASSA5P-FP	£2.75	£2.40	£2.30	£2.25
A4	ASSA4P-FP	£3.72	£3.60	£3.26	£3.14
A3	ASSA3P-FP	£6.57	£6.02	£5.90	£5.42

PRICE EACH – Other sizes manufactured on request.

With adhesive foam pads (landscape)

Size	Code	1+	25+	100+	500+
A5	ASSA5L-FP	£2.78	£2.45	£2.34	£2.29
A4	ASSA4L-FP	£3.81	£3.68	£3.32	£3.24
A3	ASSA3L-FP	£6.84	£6.52	£6.02	£5.46

PRICE EACH – Other sizes manufactured on request.

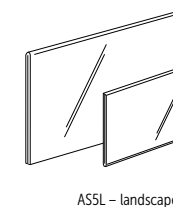
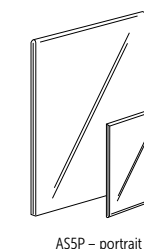





### MPH WOODEN MAGNETIC POSTER HANGER

NEW



Quick and easy poster updates

- Wooden Magnetic Poster Hanger for easily displaying posters and graphics
- Available in 4 widths: 30cm, 40cm, 50cm and 60cm
- Can display posters of any length and up to 2kg in weight
- Made from high-quality wood with a soft-touch surface
- Strong magnets keep your graphics in place, with a soft felt lining protecting them from damage
- Also available complete with your custom printed posters

Size	Code	1+	25+
300mm	MPH-300	£6.40	£5.90
400mm	MPH-400	£7.40	£6.60
500mm	MPH-500	£8.50	£7.70
600mm	MPH-600	£9.90	£8.95

PRICE PER SET

For our [printed poster](http://www.ukpos.com) options, visit [www.ukpos.com](http://www.ukpos.com)

Shop our extensive range of chalkboard and wooden POS visit [www.ukpos.com](http://www.ukpos.com)



### PSS1 SUSPENDED POSTER GRIPPER

- Ceiling hanging poster gripper ideal for supermarkets, events and retailers
- Designed with a hinged shut function to grip your graphic
- Consists of two aluminium rails, four end caps and two slide hangers
- Available in silver or black finish, in various sizes to suit your posters

Size (mm)	Colour	Code	1+	10+
420	Silver	PSS1-420	£3.90	£3.50
594	Silver	PSS1-594	£5.41	£4.81
841	Silver	PSS1-841	£7.30	£6.50
1000	Silver	PSS1-1000	£10.34	£9.40
1200	Silver	PSS1-1200	£10.78	£9.60
594	Black	PSS1K-594	£8.10	£7.90
841	Black	PSS1K-841	£10.60	£10.31
1000	Black	PSS1K-1000	£12.34	£11.90
1200	Black	PSS1K-1200	£14.80	£14.15

PRICE PER SET – Custom sizes available on request.



Simple, easy poster snapping

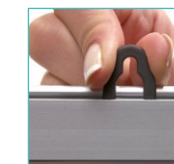

Easy to adjust sliding hanging clips



Snap frame profile

FROM  
**£3.50**

For our [printed poster](http://www.ukpos.com) options, visit [www.ukpos.com](http://www.ukpos.com)





### 109 SMALL SUPERGRIP CARD HOLDERS

- SuperGrip card holders for use on countertops or shelves
- Supplied with permanent adhesive to secure display
- Designed with various base widths and lengths
- Accepts material up to 1.4mm thick
- Manufactured from clear PVC
- Supplied in packs of 100

FROM  
**£3.65**

PRICE PER PACK OF 100				
Size (mm)	Code	1+	5+	10+
13 W x 25 L	109-100	£4.84	£3.90	£3.65
13 W x 75 L	109-300	£13.31	£10.80	£9.80

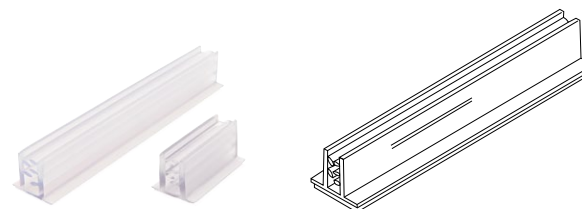

### 2230 STRAIGHT TABLETOP CARD HOLDER

- Small card holder ideal for holding product specs or pricing
- Accepts material up to 1mm thick
- Manufactured from clear styrene
- 50mm W x 46mm D
- Supplied in packs of 100

PRICE PER PACK OF 100				
Size (mm)	Code	1+	5+	10+
50 W x 46 D	2230-SU	£19.86	£17.53	£15.76

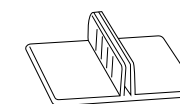

### WCS WHITE CARDBOARD STRUTS

- Create a freestanding poster display for your countertops
- A simple and cost-effective display solution
- These struts are for adhering to your display cards
- Available with or without adhesive
- Manufactured from white cardboard

FROM  
**£0.06**

#### AWCS - Strut with adhesive

Strut height (mm)	Code	10+	100+	500+	1000+
100	AWCS90	£0.21	£0.15	£0.14	£0.13
150	AWCS140	£0.24	£0.19	£0.17	£0.15
200	AWCS190	£0.25	£0.21	£0.20	£0.18
250	AWCS240	£0.45	£0.26	£0.24	£0.23
300	AWCS290	£0.55	£0.28	£0.26	£0.25

MINIMUM 10/PRICE EACH

#### WCS - Strut with no adhesive

Strut height (mm)	Code	10+	100+	500+	1000+
100	WCS90	£0.15	£0.08	£0.07	£0.06
150	WCS140	£0.16	£0.12	£0.10	£0.09
200	WCS190	£0.17	£0.12	£0.11	£0.10
250	WCS240	£0.28	£0.15	£0.14	£0.13
300	WCS290	£0.34	£0.18	£0.16	£0.15

MINIMUM 10/PRICE EACH

#### AWCS - Printed card with strut and adhesive

Size	Orientation	Code	5+	10+	25+	50+
A5 P	Portrait	AWCS1A5-PRINTED	£6.49	£3.96	£3.41	£2.95
A4 P	Portrait	AWCS1A4-PRINTED	£7.29	£4.45	£3.35	£2.95
A3 P	Portrait	AWCS1A3-PRINTED	£8.14	£5.37	£4.51	£3.66

MINIMUM 5/PRICE EACH

### CL10 TICKET HOLDER CLIP

- Double-ended plastic ticket holder clip
- Available in clear or black
- Clip can be altered to your desired angle
- Rubber-lined clamp secures to surfaces 25mm thick
- Spring clamp can support cards or tickets up to 9.5mm thick

Colour	Code	1+	10+	100+	500+
Clear	CL10	£0.96	£0.78	£0.59	£0.53
Black	CL10K	£1.14	£0.95	£0.76	£0.67

PRICE EACH - Other variations available on request.







**FW5 PVC ADHESIVE FLEXIBLE WALLET**

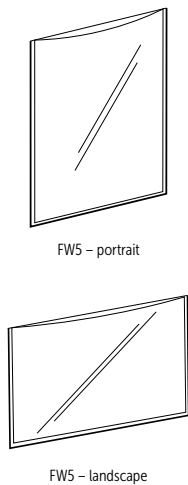

**Portrait short side opening**

Insert size	Code	10+	100+	500+	1000+
95 x 60mm	FW595P	£0.33	£0.15	£0.13	£0.12
A7	FW5A7P	£0.31	£0.16	£0.15	£0.14
A6	FW5A6P	£0.34	£0.18	£0.17	£0.15
A5	FW5A5P	£0.37	£0.24	£0.23	£0.18
A4	FW5A4P	£0.56	£0.38	£0.35	£0.28
A3	FW5A3P	£1.18	£0.97	£0.92	£0.77

MINIMUM 10/PRICE EACH – Other sizes manufactured on request.

**Landscape long side opening**

Insert size	Code	10+	100+	500+	1000+
60 x 95mm	FW560L	£0.33	£0.15	£0.13	£0.12
A7	FW5A7L	£0.31	£0.16	£0.15	£0.14
A6	FW5A6L	£0.34	£0.18	£0.17	£0.15
A5	FW5A5L	£0.37	£0.24	£0.23	£0.18
A4	FW5A4L	£0.56	£0.38	£0.35	£0.28
A3	FW5A3L	£1.18	£0.97	£0.92	£0.77

MINIMUM 10/PRICE EACH – Other sizes manufactured on request.

FROM **£0.12**

- Flexible wallet with an adhesive back
- Apply to almost any surface instantly
- Designed with an open top for easy updates
- Manufactured from 190 micron clear PVC

**FW1 PVC FLEXIBLE WALLET**

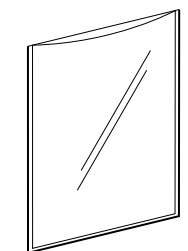

- Top-opening wallet for simple updates
- Ideal for mounting to walls and products using adhesive (not supplied)
- Manufactured from 190 micron clear PVC

Insert size	Code	10+	100+	500+	1000+
A7	FW1A7	£0.30	£0.16	£0.15	£0.13
A6	FW1A6	£0.33	£0.18	£0.16	£0.14
A5	FW1A5	£0.37	£0.23	£0.20	£0.17
A4	FW1A4	£0.56	£0.38	£0.35	£0.28

MINIMUM 10/PRICE EACH – Other sizes manufactured on request.

**FW2 PVC WALLET WITH WELDED HOLE**

- Top-opening wallet which is great for quick updates
- Double sided for optimum advertising
- Reinforced welded hole for tie attachment
- Manufactured from 190 micron clear PVC

FROM **£0.13**

Insert size	Code	10+	100+	500+	1000+
A7	FW2A7	£0.28	£0.18	£0.16	£0.13
A6	FW2A6	£0.29	£0.18	£0.17	£0.13
1/3 A4 (third A4)	FW21/3A4	£0.32	£0.18	£0.15	£0.14
A5	FW2A5	£0.36	£0.28	£0.26	£0.21
A4	FW2A4	£0.56	£0.43	£0.40	£0.32

MINIMUM 10/PRICE EACH – Other sizes manufactured on request.

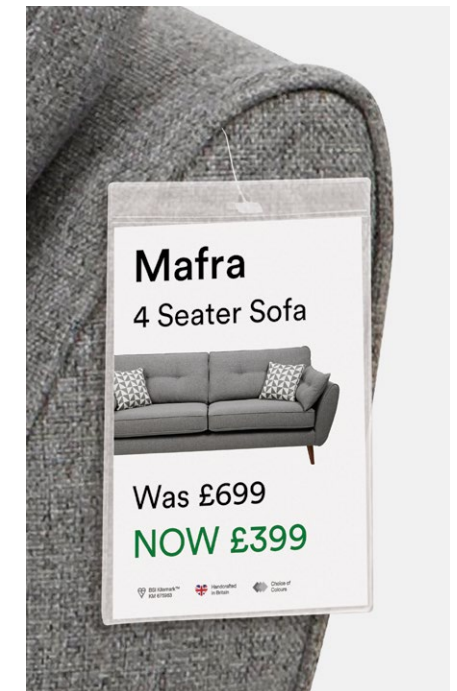
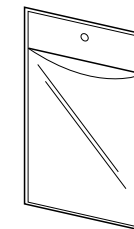

**FW3 PVC WALLET WITH METAL EYELET**

- Wallet designed with a metal eyelet for attachment
- Open top for quick and easy updates
- Manufactured from 190 micron clear PVC

Insert size	Code	10+	100+	500+	1000+
A7	FW3A7	£0.44	£0.33	£0.26	£0.20
A6	FW3A6	£0.47	£0.36	£0.27	£0.24
A5	FW3A5	£0.67	£0.38	£0.29	£0.26
A4	FW3A4	£1.12	£0.61	£0.53	£0.47

MINIMUM 10/PRICE EACH – Other sizes manufactured on request.



**FW4 PVC WALLET WITH TRIANGULAR HEADER**

- Triangular head with a welded hole for attachments
- Top opening for quick and easy updates
- Manufactured from 190 micron clear PVC

Insert size	Code	10+	100+	500+	1000+
A7	FW4A7	£0.40	£0.24	£0.18	£0.16
A6	FW4A6	£0.44	£0.28	£0.22	£0.18
A5	FW4A5	£0.50	£0.34	£0.28	£0.23

MINIMUM 10/PRICE EACH – Other sizes manufactured on request.

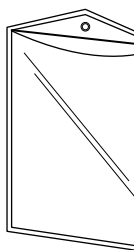



**PB4 TOP FITTING SHELF TALKER**

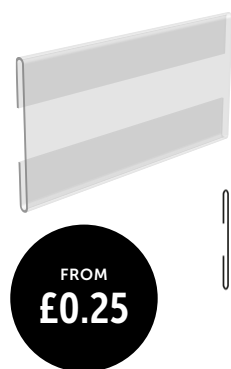

- Create a standout pricing or promotional display on your shelf edges
- Top of the talker sits in line with your scanning rail
- Manufactured from 480 micron clear PVC

Size (W x H)	Code	25+	100+	500+	1000+
6" x 3"	PB463	£0.50	£0.39	£0.29	£0.25
8" x 3"	PB483	£0.54	£0.45	£0.30	£0.27

MULTIPLES OF 25/PRICE EACH – Other sizes manufactured on request.

FROM  
**£0.25**



**PB1A CENTRAL FITTING SHELF TALKER**

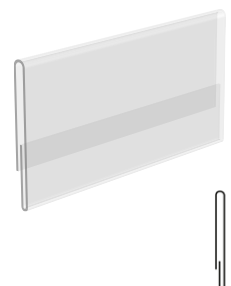

- Create a clear and effective shelf edge display
- Ideal for central fit on your scanning rail
- Manufactured from 480 micron clear PVC

Size (W x H)	Code	25+	100+	500+	1000+
6" x 3"	PB1A63	£0.59	£0.55	£0.31	£0.30
8" x 3"	PB1A83	£0.62	£0.56	£0.35	£0.33

MULTIPLES OF 25/PRICE EACH – Other sizes manufactured on request.

**PB5 THREE BEND CENTRAL FITTING SHELF TALKER**

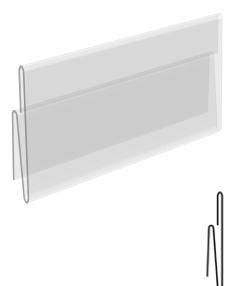

- Display prices, offers or new-in ranges
- Ideal for a central fit on your scanning rail
- Three bend design allows for a stronger grip
- Manufactured from 480 micron clear PVC

Size (W x H)	Code	25+	100+	500+	1000+
6" x 3"	PB563	£0.52	£0.47	£0.45	£0.41
8" x 3"	PB583	£0.62	£0.53	£0.47	£0.42

MULTIPLES OF 25/PRICE EACH – Other sizes manufactured on request.

**PB8 HINGED SHELF TALKER**

- Display your promotions and prices directly on your shelf
- Hinged function gives easy accessibility to the shelf beneath, protecting both your shelf signs and your products
- Manufactured from clear PVC

Size (W x H)	Code	25+	100+	500+	1000+
4" x 3"	PB843	£0.31	£0.19	£0.18	£0.16
6" x 3"	PB863	£0.33	£0.19	£0.18	£0.17
8" x 3"	PB883	£0.42	£0.30	£0.26	£0.21

MULTIPLES OF 25/PRICE EACH – Other sizes manufactured on request.

FROM  
**£0.16**

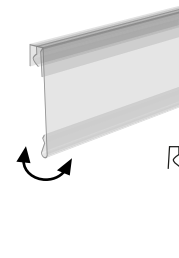

Products designed around you

Let our in-house experts design and manufacture products to suit your needs and price point today.

To find out more visit our website or **CALL 0161 516 2467**



**PB14 CLIP ON CENTRAL FITTING SHELF TALKER**

- Versatile shelf talker that can clip to the top or bottom of most types of data strip
- Perfect for stores with varying styles of shelving and data strip
- Manufactured from clear extruded plastic

Size (W x H)	Code	25+	100+	500+	1000+
6" x 3"	PB1463	£0.43	£0.25	£0.23	£0.21
8" x 3"	PB1483	£0.49	£0.36	£0.31	£0.26

MULTIPLES OF 25/PRICE EACH – Other sizes manufactured on request.

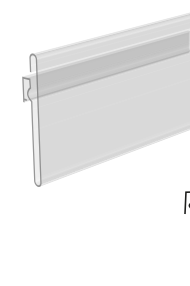

**PB12 HOOK ON SHELF TALKER**

- Update your shelf edge display with a shelf talker
- Fits over shelf risers up to 10mm thick
- Manufactured from 480 micron clear PVC

Size (W x H)	Code	25+	100+	500+	1000+
6" x 3"	PB1263	£0.82	£0.71	£0.53	£0.49
8" x 3"	PB1283	£0.86	£0.73	£0.58	£0.51

MULTIPLES OF 25/PRICE EACH – Other sizes manufactured on request.

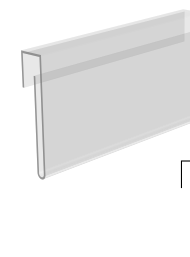



## PS2 PVC PALLET CARD HOLDER



- Add promotional messages directly to your pallet or shelf
- The portrait card holder securely fits between outers of pallet
- Manufactured from 480 micron clear PVC
- Bespoke sizes available on request

Size	Code	1+	25+	100+	500+
A4	PS2A4	£1.30	£0.84	£0.59	£0.56

PRICE EACH – Other sizes available on request.

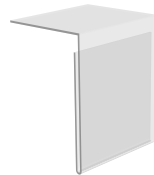

**DID YOU KNOW** LESS THAN A QUARTER OF SHOPPERS SPEAK TO SHOP ASSISTANTS WHEN OUT SHOPPING? UP-TO-DATE POS WILL ENSURE YOUR CUSTOMERS HAVE ALL THE INFORMATION THEY NEED.

## WB1 WOBLER STRIPS



FROM  
**£2.05**

- Display promotional messages on your data strip
- Designed with adhesive foam pads at each end
- Adhesive is on the same side at each end
- Supplied in packs of 100

### PRICE PER PACK OF 100

Length (mm)	Code	1+	5+	10+
150	WB1-150	£2.97	£2.60	£2.05
205	WB1-205	£3.15	£2.75	£2.27



## ROU PRINTED ROUNDELS FOR WOBLERS AND SIGN HOLDERS

NEW



- Custom-printed round signs for use with shelf wobbler strips
- Printed on 200gsm silk finish card
- Choose between single or double-sided prints
- Available in 60mm, 80mm or 100mm diameters
- Compatible with the WB1, WB2, WB3, WB4, WB7 and BS2 ranges

Dia.	Code	100+	250+	500+	1000+
60mm	ROU-S60-PRINTED	£1.50	£0.90	£0.75	£0.50
80mm	ROU-S80-PRINTED	£1.55	£1.00	£0.85	£0.60
100mm	ROU-S100-PRINTED	£1.60	£1.25	£1.10	£0.75

PRICE EACH



## DBR FLAT SHELF EDGE DATA STRIPS

- Ideal for displaying price tickets on the shelf edge
- Self adhesive strip for easy fixing to your shelf
- Designed with a 39mm or 76mm height as standard
- Other heights available on request

FROM  
**£0.57**

### Clear

L x H (mm)	Code	10+	50+	100+	250+
1000 x 39	DBR39C	£1.47	£0.98	£0.70	£0.57
1200 x 39	DBR39C-1200	£2.18	£1.45	£1.05	£0.72
1320 x 39	DBR39C-1320	£2.50	£1.60	£1.16	£0.79
1000 x 76	DBR76C	£2.10	£1.63	£1.45	£1.31

PRICE EACH/MINIMUM 10 - Other colours and sizes available on request.

### White

L x H (mm)	Code	10+	50+	100+	250+
1000 x 39	DBR39W	£1.47	£0.98	£0.70	£0.57

PRICE EACH/MINIMUM 10 - Other colours and sizes available on request.



## DS1 ADHESIVE SHELF TICKET STRIP

- Premium shelf ticket holder for displaying prices, promos or offers
- High-quality design offers excellent viewing clarity of your data
- Complete with adhesive tape applied to back to enable fixing
- Can be cut to your desired size using a sharp blade
- Available to suit either 40mm or 76mm high tickets
- Manufactured from 480 micron clear PVC
- Length: 1000mm

Premium quality  
shelf strip

Height (mm)	Code	10+	50+	100+	250+
40	DS1-40	£2.17	£1.73	£1.47	£1.19
76	DS1-76	£2.69	£1.98	£1.69	£1.45

MULTIPLES OF 10/PRICE EACH – Other sizes manufactured on request.



## DS2 DATA STRIP WITH FLAT ADHESIVE RETURN

- Display prices, branding or promotions on your shelf edge
- Complete with adhesive tape applied to return for easy fixing
- Facility to take 40mm or 76mm height tickets
- Manufactured from 700 micron clear PVC
- Supplied in 1000mm lengths

Height (mm)	Code	10+	50+	100+	250+
40	DS2-40	£3.06	£2.63	£2.31	£2.15
76	DS2-76	£3.15	£2.98	£2.77	£2.61

MULTIPLES OF 10/PRICE EACH – Other sizes manufactured on request.







**AFS3 MAGNETIC AISLE SIGN HOLDER**

- Display promotions along your retail aisle
- Designed with a magnetic base to attach to shelves
- Supplied with adjustable hangers to suit your banner
- Available with a 150mm x 750mm custom-printed banner
- Hinged arm to change position
- Overall hanger size: 250mm L x 70mm H

With print	Code	1+	10+	100+
No	AFS3	£3.40	£2.55	£1.95
Yes	AFS3-PRINTED	£18.25	£9.13	£4.76

PRICE EACH



**AFS1 AISLE SIGN FIXTURE AND HOOKS**



- Telescopic tube kit designed for shelving uprights
- Available with optional double-sided printed banner
- Optional banner measures 150mm x 750mm (1000 micron)
- Ideal for highlighting products or promotions along aisles
- Modern silver anodised aluminium finish
- Supplied with hook attachments
- Length adjustable from 605mm - 750mm

With print	Code	1+	25+	100+
No	AFS1	£7.23	£5.67	£4.83
Yes	AFS1-PRINTED	£21.89	£11.45	£7.47

PRICE EACH



**SUL/SUL1 LED LIGHT BAR OR STRIP KIT**

NEW

- LED kits for creating eye-catching shelf displays
- Available in multiple kits of between one and four ticket strips to suit your shelving requirements
- Each kit comes with a 1000mm magnetic track and 96W power adaptor
- No extra fixings required
- Magnetic LED Light Bars available in two lengths: 960mm or 1160mm
- Adhesive LED Light Strip Bars available in two lengths: 970mm or 1170mm

**Magnetic LED Light Bar Kit**

Code	Shelves	Length	1+
SUL-3M-116-1000mm	Three	1160mm	£145.04
SUL-4M-116-1000mm	Four	1160mm	£171.38
SUL-3M-96-1000mm	Three	960mm	£135.05
SUL-4M-96-1000mm	Four	960mm	£158.49

PRICE PER KIT

**Self Adhesive LED Strip Kit**

Code	Shelves	Length	1+
SUL-3A-117-1000mm	Three	1170mm	£112.67
SUL-4A-117-1000mm	Four	1170mm	£128.65
SUL-3A-97-1000mm	Three	970mm	£107.27
SUL-4A-97-1000mm	Four	970mm	£121.45

PRICE PER KIT

**Easy connection with twist and lock system**

Clip your LED connector into the power track and then simply twist and lock to hold in place.



SUL Magnetic LED Light Bar Kit



SUL1 Self Adhesive LED Strip Kit

**Enhance your shelf edges with LED data strips**

Our LED data strips are cleverly designed to illuminate both your shelf labels, and the shelf below. Highlighting products and prices using LED ticket strips gives your business a modern, high-quality feel which creates an eye-catching shelving display.

Product code **ITS** available online [www.ukpos.com](http://www.ukpos.com)





## KBL LED ILLUMINATED CEILING TO FLOOR POSTER KIT

LED PRODUCT



Can be displayed in portrait or landscape



- Floor-to-ceiling LED poster cable display
- Ideal for estate agent and restaurant window displays
- Can be displayed in portrait or landscape orientation
- Stylish silver border will neatly frame your graphic
- Designed with double-sided 14mm thick acrylic LED-lit panels
- Includes four clamps per poster, two 4m cables, one transformer plus Allen key and fixings

FROM  
**£89.00**

Size	Pockets	Code	Price
A4	1 pocket	KBL1A4	£89.00
A4	2 pockets	KBL2A4	£139.00
A4	3 pockets	KBL3A4	£189.00
A4	4 pockets	KBL4A4	£239.00
A3	1 pocket	KBL1A3	£113.00
A3	2 pockets	KBL2A3	£189.00
A3	3 pockets	KBL3A3	£259.00
A3	4 pockets	KBL4A3	£338.00
A2	1 pocket	KBL1A2	£190.00
A2	2 pockets	KBL2A2	£352.00
A1	1 pocket	KBL1A1	£265.00
A1	2 pockets	KBL2A1	£445.00

PRICE PER KIT – Other sizes manufactured on request.

## KB1 CEILING TO FLOOR CABLE POSTER KITS

- Ceiling-to-floor cable poster kit with portrait or landscape options
- Customisable display using one to five poster pockets
- Includes two 4m steel cables with satin chrome fixings
- More pocket sizes and combinations available online

FROM  
**£34.96**

### Portrait

Size	Pockets	Code	Price
A4	3 pockets	KB13A4P	£35.30
A3	2 pockets	KB12A3P	£44.53
A2	1 pocket	KB11A2P	£36.50
A1	1 pocket	KB11A1P	£49.86
A0	1 pocket	KB11A0P	£141.00

PRICE PER KIT

### Landscape

Size	Pockets	Code	Price
A4	3 pockets	KB13A4L	£34.96
A3	2 pockets	KB12A3L	£51.46
A2	1 pocket	KB11A2L	£36.19
A1	1 pocket	KB11A1L	£64.85

PRICE PER KIT



All our kits include high quality satin anodised fixings.



Other sizes manufactured on request

## KB2 WALL MOUNTED CABLE POSTER KIT

- Wall-mounted cable kit with portrait or landscape options
- Customisable display using one, two or three poster pockets
- Includes two 4m cables and satin anodised fixings

### Portrait

Size	Pockets	Code	Price
A4	3 pockets	KB23A4P	£62.00
A3	2 pockets	KB22A3P	£60.50
A2	1 pocket	KB21A2P	£61.00
A1	1 pocket	KB21A1P	£76.90
A0	1 pocket	KB21A0P	£152.46

PRICE PER KIT

### Landscape

Size	Pockets	Code	Price
A4	3 pockets	KB23A4L	£63.50
A3	2 pockets	KB22A3L	£52.00
A2	1 pocket	KB21A2L	£62.40
A1	1 pocket	KB21A1L	£79.80

PRICE PER KIT

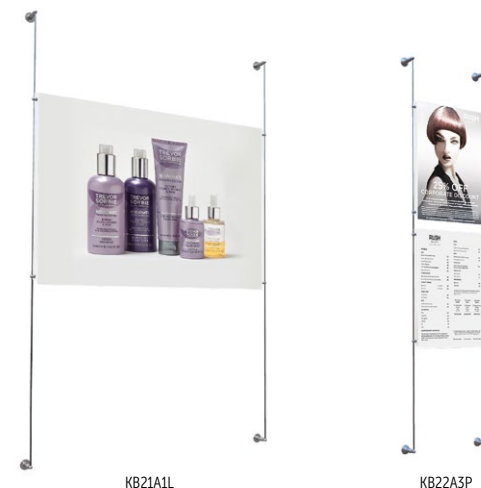

Other sizes manufactured on request





**AA5 CEILING TO SIGN CABLE WITH FIXINGS**



FROM  
**£4.90**

- 2.5m cable with ceiling-to-sign fixings
- Stylish satin anodised finish
- Grips material 3mm to 7mm thick
- Two Allen keys included

Code	Price
AA5	£4.90

PRICE EACH

**SEC WINDOW DISPLAY POSTER HOLDER**



- Poster holder with clear suction cups
- Ideal for retail window displays
- Add custom-printed posters if required
- Manufactured from:  
A4 in 2mm impact-resistant acrylic  
A3 and A2 in 3mm impact-resistant acrylic  
A1 in 1.5mm PETG

FROM  
**£6.92**

Size	Code	Suction cups	1+	25+	100+
A4 portrait	SECA4	4 cups	£7.72	£7.33	£6.92
A3 portrait	SECA3	4 cups	£17.55	£16.44	£14.83
A2 portrait	SECA2	6 cups	£42.44	£33.25	£30.09
A1 portrait	SECA1	8 cups	£48.69	£41.63	£37.22

PRICE EACH

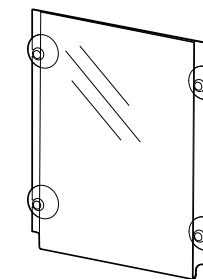

**EAC1 ACRYLIC EASY-ACCESS POSTER HOLDER PORTRAIT**

- Double-sided poster pocket for cable kits
- Available in portrait or landscape orientation
- Simple way to display and update posters
- Larger sizes (A2, A1 and A0) are supplied with grips to secure poster
- Manufactured from 2mm or 3mm acrylic, depending on size
- Fixings not included

Size	Thickness	Code	Price
A5	2mm	EAC1-ASP	£3.10
A4	2mm	EAC1-A4P	£4.39
A3	3mm	EAC1-A3P	£8.62
A2	3mm	EAC1-A2P	£18.54
A1	3mm	EAC1-A1P	£31.08
A0	3mm	EAC1-A0P	£93.63

PRICE EACH – Other sizes/formats manufactured on request.

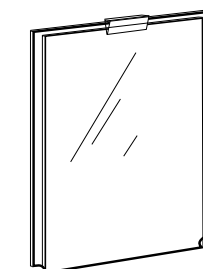

**AA4 FLOOR TO CEILING CABLE WITH FIXINGS**



AG01 Single Vertical Grip (included)

- 4m long cable for floor-to-ceiling display
- 1.5mm diameter steel cable
- Includes fixings in a satin anodised finish
- Supplied with an Allen key

Code	Price
AA4	£6.55

PRICE EACH

**AG1 SINGLE SIDED SATIN ANODISED VERTICAL GRIP**



- Satin anodised silver grips to hold poster panels in cable window displays
- Single-sided vertical grip for edge panels
- 10mm smaller size diameter is to suit panels 1mm - 4mm
- 16mm larger size diameter is to suit panels 3mm - 7mm

Size (Dia x length)	Code	Price
10mm x 15mm	AG01S	£1.18
16mm x 19mm	AG01	£1.66

PRICE EACH



**AG2 Double Sided Vertical Grip** available: [www.ukpos.com](http://www.ukpos.com)



**EAC2 ACRYLIC EASY-ACCESS POSTER HOLDER LANDSCAPE**



- Double-sided landscape pocket for cable kits
- Simple way to display and update posters
- A2 and A1 supplied with grips to secure poster
- Manufactured from 2mm or 3mm acrylic, depending on size
- Fixings not included

Size	Thickness	Code	Price
A5	2mm	EAC2-A5L	£3.14
A4	2mm	EAC2-A4L	£4.39
A3	2mm	EAC2-A3L	£8.22
A2	3mm	EAC2-A2L	£18.60
A1	3mm	EAC2-A1L	£39.74

PRICE EACH – Other sizes/formats manufactured on request.



WML ILLUMINATED WALL MOUNTED POSTER KIT (BLACK OR SILVER BORDER)

LED PRODUCT



Black



Silver

- Edge-lit poster holder for a modern and attractive poster display
- Each poster holder comes with two acrylic panels and four standoff wall mounts
- Choice of a silver or black frame
- Front panel designed with a border to frame your artwork
- Can be mounted portrait or landscape
- Includes wall fixings and power pack with 3m cable
- Add custom-printed backlit posters if required



Silver

Size	Colour	Code	Overall Size	1+	5+
A4	Silver	WMLA4	323 x 410mm	£69.43	£63.80
A3	Silver	WMLA3	410 x 533mm	£115.00	£99.00
A2	Silver	WMLA2	533 x 707mm	£159.00	£138.00
A1	Silver	WMLA1	707 x 954mm	£259.50	£233.00

PRICE EACH – Other sizes manufactured on request.

Black

Size	Colour	Code	Overall Size	1+	5+
A3	Black	WMLKA3	410 x 533mm	£115.00	£99.00
A2	Black	WMLKA2	533 x 707mm	£159.00	£138.00
A1	Black	WMLKA1	707 x 954mm	£259.50	£233.00

PRICE EACH – Other sizes manufactured on request.

WM1 ACRYLIC SIGN STANDOFFS HOLE MOUNT

- Through hole panel support in a variety of finishes
- WM1-12/20 Designed with a 12mm diameter and 20mm projection
- WM1-20/25 Designed with a 20mm diameter and 25mm projection
- Grips material from 2mm – 12mm thick
- WM1-12/20 requires 9mm diameter holes, WM1-20/25 requires 10mm diameter holes
- Screws included
- More diameters and projections available online

FROM  
£0.94

Diameter	Finish	Code	1+
12mm	Satin anodised	WM1-12/20	£0.94
12mm	Chrome	WM1C-12/20	£1.29
12mm	Black	WM1K-12/20	£1.29
12mm	Gold	WM1G-12/20	£1.48
20mm	Satin anodised	WM1-20/25	£1.95
20mm	Chrome	WM1C-20/25	£1.62
20mm	Black	WM1K-20/25	£1.62
20mm	Gold	WM1G-20/25	£2.17

PRICE EACH – Other finishes available.



WM1-12/20 Satin Anodised



WM1-20/25 Satin Anodised



Available in three alternative colours:



Polished chrome



Satin black



Polished gold

WMHK ACRYLIC WALL MOUNTED POSTER KIT PORTRAIT



- Stylish through-hole easy-access poster holder
- A modern way to display graphics in your store
- Includes four satin anodised wall mounts
- A2 size and above includes a poster clip
- Manufactured from 2mm and 3mm acrylic

FROM  
£8.34

Size	Code	1+	10+
A5	WMHK12A5	£9.90	£8.34
A4	WMHK12A4	£12.76	£11.67
A3	WMHK12A3	£20.34	£18.23
A2	WMHK12A2	£29.53	£26.23
A1	WMHK12A1	£45.00	£38.90

PRICE EACH – Other sizes available

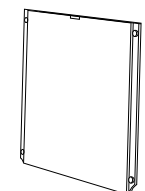

WM1-12/20 wall mounts included







**SPP BRANDED WALL MOUNTED KIT**



- Modern acrylic plaque, available blank or personalised with your custom branding
- Ideal for use around offices or corporate buildings
- Simple design uses just one panel printed on the reverse
- Can be written on using dry wipe pens
- Manufactured from premium 5mm acrylic with radius corners
- A6 kit includes two wall mounts
- A5, A4, A3, A2 and A1 kits include four wall mounts
- A0 kit includes six wall mounts

Size	Code	1+
A6	SPPA6-BRANDED	£19.67
A5	SPPA5-BRANDED	£24.86
A4	SPPA4-BRANDED	£28.34
A3	SPPA3-BRANDED	£39.68
A2	SPPA2-BRANDED	£59.03
A1	SPPA1-BRANDED	£89.50
A0	SPPA0-BRANDED	£149.82

PRICE EACH – Other sizes and colours available.

Also available with:



Satin black



Polished gold



**WMP ACRYLIC WALL MOUNTED PANEL POSTER KIT**



- Stylish wall-mounted poster holder for single-sided advertising
- Available in A5 - A0 sizes with a clear border frame
- Designed with modern radius corners
- Can be used portrait or landscape
- Consists of two acrylic panels and up to six standoff wall mounts
- Includes fixings

FROM  
**£10.88**

Size	Code	Panel thickness	Border	Overall Size	1+	5+
A5	WMP12A5	3mm	30mm	208 x 270mm	£13.31	£10.88
A4	WMP12A4	3mm	40mm	290 x 377mm	£15.50	£14.34
A3	WMP20A3	4mm	50mm	397 x 520mm	£38.20	£33.78
A2	WMP20A2	5mm	50mm	520 x 694mm	£61.05	£54.95
A1	WMP20A1	5mm	50mm	694 x 941mm	£109.63	£102.24
A0	WMP20A0	6mm	50mm	1290 x 941mm	£207.57	£196.47

PRICE EACH



Radius corners for safety



Wall mounts included



**WMSK ACRYLIC PANEL POSTER KIT WITH SIDE GRIP**



- Stylish side grip easy-access poster holder
- A modern way to display graphics in your store
- Includes four satin anodised standoff wall mounts
- A2 size and above include a poster clip
- Manufactured from 3mm thick clear acrylic
- Screw fixings included

**Portrait**

Size	Code	1+	10+
A5	WMSK20A5P	£12.93	£11.25
A4	WMSK20A4P	£14.56	£12.53
A3	WMSK20A3P	£21.53	£17.87
A2	WMSK20A2P	£29.81	£25.86
A1	WMSK20A1P	£47.35	£42.34
A0	WMSK20A0P	£108.63	£103.82

PRICE EACH – Other sizes available.

**Landscape**

Size	Code	1+	10+
A5	WMSK20A5L	£12.93	£11.55
A4	WMSK20A4L	£14.75	£12.84
A3	WMSK20A3L	£21.10	£17.43
A2	WMSK20A2L	£30.55	£26.75
A1	WMSK20A1L	£51.20	£46.23

PRICE EACH – Other sizes available.

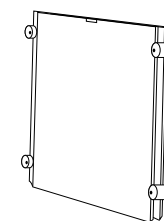





### PFG3 SILVER 25MM SNAP FRAME

clipable

- Wall-mounted silver poster frame with 25mm profile
- Front-opening spring mechanism for easy and quick updates
- Includes a UV anti-glare protective cover
- Pre-drilled styrene back panel for instant mounting
- Add custom-printed posters if required
- Choose between screws or adhesive pads for fixing

FROM  
**£2.95**

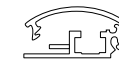

25mm frame

Poster size	Code	1+	10+
A5	PFG3A5	£3.30	£3.15
A4	PFG3A4	£2.97	£2.95
A3	PFG3A3	£4.95	£4.50
A2	PFG3A2	£6.95	£6.65
A1	PFG3A1	£10.64	£10.30
A0	PFG3A0	£29.99	£28.00

PRICE EACH – Other sizes and finishes manufactured on request.



Quick and easy poster change



Fixings included

**Print Service**



Available with adhesive foam pads for easy wall mounting. Visit [www.ukpos.com](http://www.ukpos.com) for more information

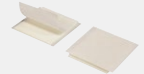

### PFG9 BLACK 25MM SNAP FRAME

clipable

- Wall-mounted poster frame in A5 - A0 sizes with a 25mm profile
- Front-opening mechanism for easy and quick updates
- Includes a UV anti-glare protective cover
- Pre-drilled styrene back panel for instant mounting
- Available with an optional printed poster
- Available with either screws or adhesive pads for wall mounting

FROM  
**£3.38**

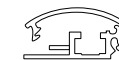

25mm frame

Poster size	Code	1+	10+
A5	PFG9A5	£3.77	£3.38
A4	PFG9A4	£4.10	£3.99
A3	PFG9A3	£6.43	£5.55
A2	PFG9A2	£9.46	£8.50
A1	PFG9A1	£17.50	£16.90
A0	PFG9A0	£29.75	£28.43

PRICE EACH – Other sizes and finishes manufactured on request.

Available in a variety of colours

Visit [www.ukpos.com](http://www.ukpos.com)



WHITE

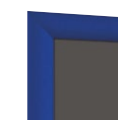

BLUE



RED



WOOD



GOLD



CHROME





SFGX BUDGET BACKLESS SNAP FRAME

LOW PRICE



FROM  
**£1.99**



25mm frame

- Stylish backless snap frame creates a lightweight budget display
- Your wall or surface acts as the back panel to secure posters
- Designed with a front-opening mechanism for simple updates
- Includes a PVC UV anti-glare poster cover to protect your inserts
- Screw fixings included
- Add custom-printed posters if required

Poster size	Code	1+	10+	100+
A4	SFGXA4	£2.49	£2.29	£1.99
A3	SFGXA3	£4.10	£3.87	£3.63

PRICE EACH – Other sizes and finishes manufactured on request.



Fixings included



Quick and easy poster change

PFG8 SILVER SNAP FRAME 25MM WITH ROUND CORNERS

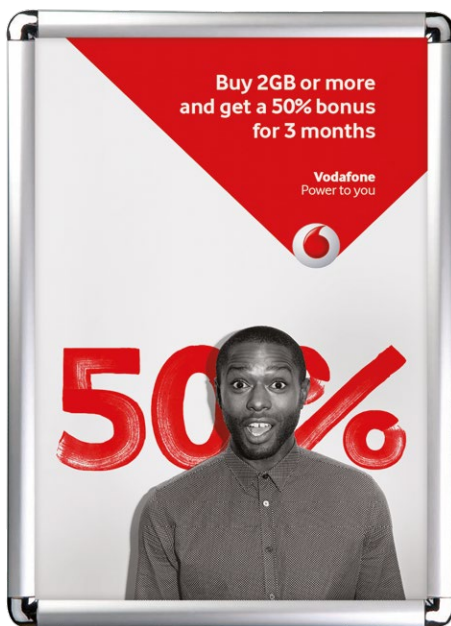

FROM  
**£3.69**



25mm frame

- Wall-mounted silver poster frame with 25mm profile
- Designed with stylish rounded chrome corners
- Front-opening mechanism for easy and quick updates
- Includes a UV anti-glare protective cover
- Pre-drilled styrene back panel for instant mounting
- Fixings included - choose from screws or adhesive pads
- Available with custom-printed posters

Poster size	Code	1+	10+
A4	PFG8A4	£3.92	£3.69
A3	PFG8A3	£5.23	£4.86
A2	PFG8A2	£7.71	£7.51
A1	PFG8A1	£11.37	£10.53

PRICE EACH – Other sizes and finishes manufactured on request.



Quick, easy poster change



Fixings included



SLF LOCKABLE POSTER CASE



- Silver or black poster case designed with a lock feature for security
- Wide range of sizes available
- Designed with a 45mm thick profile
- Ideal for outdoor poster displays
- Can be used portrait or landscape (portrait is recommended)
- Front panel is impact resistant
- Larger sizes (A1 or bigger) feature two locks
- All other sizes feature one key lock
- Add custom-printed posters if required

Poster size	Colour	Code	1+	5+
A4	Silver	SLF2A4	£29.60	£26.95
A3	Silver	SLF2A3	£37.50	£34.20
A2	Silver	SLF2A2	£44.77	£40.70
A1	Silver	SLF2A1	£67.00	£62.00
A0	Silver	SLF2A0	£101.00	£94.00
20" W x 30" H	Silver	SLF2S2	£69.00	£63.00
40" W x 60" H	Silver	SLF2E4	£140.75	£129.95
A4	Black	SLF2KA4	£35.00	£32.00
A3	Black	SLF2KA3	£43.00	£39.00
A2	Black	SLF2KA2	£51.00	£44.30
A1	Black	SLF2KA1	£76.00	£69.00
A0	Black	SLF2KA0	£115.00	£101.00

PRICE EACH – Other sizes and finishes manufactured on request.



SLF2K



SLF2

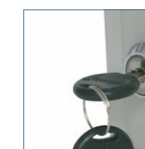

Lockable

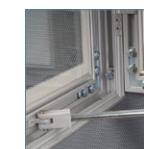

Door stay



45mm frame

Branded header option available

Call **0161 516 2467** for more information





### HLED DOUBLE SIDED HANGING LED BACKLIT SNAP FRAME

NEW LED PRODUCT



- Double Sided LED Backlit Snap Frame designed to hang from ceilings and in windows
- Can be displayed in both landscape and portrait orientations
- Uses energy-saving LEDs to provide even illumination across the poster
- Ideal for displaying eye-catching promotional displays in retail environments
- Supplied with power cable and hanging wire kit
- Add two custom-printed posters if required

Poster size	With print	Code	1+	5+
A2	No	HLEDA2	£129.00	£119.00
A1	No	HLEDA1	£180.00	£165.00
A0	No	HLEDA0	£320.00	£289.00
A2	Yes	HLEDA2-PRINTED	£157.50	£144.70
A1	Yes	HLEDA1-PRINTED	£237.00	£216.00
A0	Yes	HLEDA0-PRINTED	£434.00	£391.50

PRICE EACH



Quick, easy poster change Mains powered LED



### ECLED ECO LED LIGHT BOX

LED PRODUCT



- Wall-mounted poster frame with built-in LED illumination
- Energy-efficient LEDs with a run time of 30,000 hours
- Designed with a 25mm front-opening snap frame
- Includes wall fixings and a 12V adapter with a 2.5m cable
- Designed for use with backlit posters
- Add custom-printed posters if required

Poster size	Code	1+	10+
A3	ECLEDA3	£68.00	£60.00
A2	ECLEDA2	£110.00	£91.00
A1	ECLEDA1	£174.90	£147.00
A0	ECLEDA0	£280.50	£229.00

PRICE EACH



### MTT ILLUMINATED MONO TOTEM DISPLAY

LED PRODUCT

- Illuminated totem with a slide-in poster holder facility
- Make your displays stand out with built-in fluorescent lighting
- Poster fixes into a seamless side channel
- Designed with a heavy-duty base for stability
- Provides a double-sided display
- Designed for use with backlit posters

Unprinted

Size (mm)	Code	1+	5+
500 W x 1700 H	MTT500	£197.00	£189.00
600 W x 1700 H	MTT600	£235.00	£215.00

PRICE EACH

Printed

Size (mm)	Code	1+	5+
500 W x 1700 H	MTT500-PRINTED	£270.95	£256.15
600 W x 1700 H	MTT600-PRINTED	£308.95	£282.15

PRICE EACH



Light box protector

LED totem panels



Designed with a heavy duty base for stability



### LBD POSTER LIGHT BOX DISPLAY STAND

NEW LED PRODUCT

- Floor standing illuminated fabric tension posters available in two widths
- Bright LED backlit printed graphics, ideal for exhibitions and retail displays
- Choose between frame only or bespoke printed fabric tension banners
- The 1000mm frame is available with two banners for a double-sided display
- The 850mm frame is available with one banner for a single-sided display
- Lightweight, portable and easy to set up with no tools required

Banner size	With print	Print	Code	1+
850mm	No	None	LBD-850	£165.00
1000mm	No	None	LBD-1000	£265.00
850mm	Yes	Single-sided	LBD-850-S-PRINTED	£255.00
1000mm	Yes	Double-sided	LBD-1000-D-PRINTED	£477.00

PRICE EACH

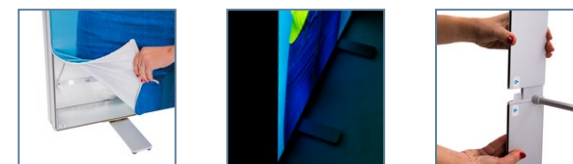

Easy-change fabric banner

Bright LED backlight

Easy to set up







**PCSS PREMIUM CURVED SIGNAGE STAND**

NEW



Portrait or landscape adjustable



Easy poster change

- Curved signage stand for A4 posters, menus and information
- Made from modern stone-effect aluminium
- Choice of two colours: earth or white pearl
- Adjustable portrait/landscape poster orientation
- Landscape stand height: 1176mm
- Portrait stand height: 1212mm
- Base size: 42mm H x 358mm Dia

Colour	Code	1+	10+
Earth	PCSSE	£78.00	£74.00
White pearl	PCSSW	£78.00	£74.00

PRICE EACH

**DPS ADJUSTABLE DOUBLE SIDED POSTER DISPLAY STAND**

NEW



Height adjustable



Also available with two Foamex boards for a double-sided display



- Floor standing metal poster holder, able to display one poster board on each side
- With easy height adjustment, this holder is also adjustable to take various board sizes
- Option to add a printed Foamex board in A0, A1, A2 or A3
- Can be placed side by side with other units for a wider display
- Adjustable stand height: 1130mm - 1500mm
- Base size: 275mm x 275mm

With printed Foamex	Size	Code	1+	5+
No	-	DPS1	£40.00	£35.70
Single Board	A3	DPS-A3S-PRINTED	£50.99	£45.82
Single Board	A2	DPS-A2S-PRINTED	£55.59	£50.05
Single Board	A1	DPS-A1S-PRINTED	£67.48	£59.62
Single Board	A0	DPS-A0S-PRINTED	£82.92	£74.34

PRICE EACH - Two Foamex boards options available on request

**MBA FREESTANDING POSTER FRAME**

clipable



- Freestanding snap frame in A3 or A4 sizes
- Choose between a black or silver frame
- Weighted base for stability
- Versatile design can be used portrait or landscape
- Ideal for menus, queues or directional signage
- Boasts quick and easy assembly
- Base size: 300mm W x 30mm H x 420mm D
- Overall height (portrait): 1090mm
- Overall height (landscape): 1050mm

FROM  
**£27.70**

Poster size	Colour	Code	1+	10+
A4	Silver	MBA4	£35.00	£27.70
A3	Silver	MBA3P	£54.50	£47.50
A4	Black	MBAKA4	£35.50	£29.86
A3	Black	MBAKA3P	£57.00	£48.00

PRICE EACH



Quick and easy poster change

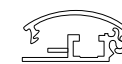

25mm frame





ABG2 A BOARD SNAP FRAME



- A board pavement sign with front-opening snap frame
- Designed with a thick 32mm profile to secure posters
- Rounded chrome corners act as a stylish safety feature
- Made with steel-galvanised back panels for strength and weight
- Includes two UV anti-glare poster protectors
- Hinged locking arms keep board secure
- Add custom-printed posters if required

Poster size	Colour	Code	1+
A2	Silver	ABG2A2	£44.00
A1	Silver	ABG2A1	£59.95
A2	Black	ABG2KA2	£45.99
A1	Black	ABG2KA1	£99.22

PRICE EACH – Other sizes and finishes manufactured on request.

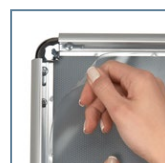

Rounded corners

SBGX BUDGET A BOARD



- A Board pavement sign with front-opening snap frame
- Designed with a 32mm thick profile to secure posters
- Made with steel galvanised back panels for strength and weight
- Includes two PVC anti-glare poster protectors
- Hinged locking arms keep board secure
- Available with custom-printed waterproof poster

Poster size	Code	1+
A2	SBGXA2	£35.00
A1	SBGXA1	£40.50

PRICE EACH – Other sizes and finishes manufactured on request.



Rounded corners

ABG SNAP FRAME A BOARD



- A board pavement sign with front-opening snap frame
- Designed with a thick 32mm profile to secure posters
- Made with steel-galvanised back panels for strength and weight
- Includes two UV anti-glare poster protectors
- Hinged locking arms keep board secure
- Also available with custom-printed posters

Poster size	Colour	Code	1+
A2	Silver	ABG1A2	£44.00
A1	Silver	ABG1A1	£59.95
A0	Silver	ABG1A0	£115.00
20" W x 30" H	Silver	ABG132	£67.00
A2	Black	ABG9A2	£54.00
A1	Black	ABG9A1	£66.50

PRICE EACH – Other sizes and finishes manufactured on request.



Snap frame mechanism makes poster changes easy



Mitred corners

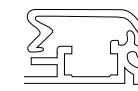

32mm frame



FROM **£44.00**





WPG7 PAVEMENT SIGN WITH WATER BASE

- Heavy-duty pavement sign with a water-fillable base
- Snap frame opening allows for quick and easy updates
- Strong mounts allow panel deflection in windy conditions
- Includes two UV anti-glare poster covers
- Built-in wheels and a handle for easy transportation (not available with WPG7A2)
- Water volume: A0 – 50 litre, A1 – 25 litre, A2 – 10 litre, 30 x 40 – 50 litre

Silver

Poster size	Code	1+
A2	WPG7A2	£65.00
A1	WPG7A1	£96.00
A0	WPG7A0	£165.00
30" x 40"	WPG743	£160.00
PRICE EACH		

Black

Poster size	Code	1+
A1	WPG9A1	£103.40
A0	WPG9A0	£175.00
PRICE EACH		



Snap frame mechanism makes poster changes easy



Built-in wheels for easy positioning (not available with WPG7A2)



Branded base available

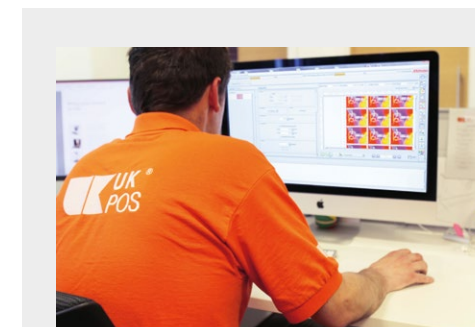

In-house printing and design services

We boast various in-house printing and design services which allow you to order your complete POS display in one go.

Upload your own finished artwork via our print site or using our online drawing app, choose one of our pre-designed signs, or opt to use our design service. We can use any logos, images and text you send us to create a finished piece of effective, print-ready artwork.

For more details, visit [www.ukpos.com](http://www.ukpos.com)



WPGL A1 LED PAVEMENT SIGN

NEW LED PRODUCT



Print Service

- Premium illuminated A1 LED Pavement Sign with snap frame opening
- Provides a soft backlight for your posters to make them stand out in darker conditions
- Double-sided display visible from many angles
- Features a rechargeable battery to power the white LED strips
- Weatherproof rated to IP56, suitable for use outdoors
- Add two custom-printed A1 Duratrans posters if required

Poster size	With print	Code	1+
A1	No	WPGLKA1	£515.00
A1	Yes	WPGLKA1-PRINTED	£572.00

PRICE EACH

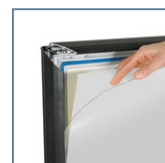

Quick and easy poster change



Rechargeable battery



SWG2 BLACK PAVEMENT SWINGER POSTER HOLDER



A1

FROM £74.77



A2

- Stylish swing sign with a magnetic poster cover
- Designed with shock-absorbing panel clips
- Header of the panel is available with bespoke branding
- Also available with two printed posters
- A1 size supplied with a water-fillable base and wheels
- A2 size supplied with a solid recycled base

Without branded header

Poster size	Code	1+	5+
A2	SWG2A2	£81.50	£74.77
A1	SWG2A1	£151.04	£143.63

PRICE EACH

With branded header

Poster size	Code	1+	5+
A2	SWG2A2-BRANDED	£142.28	£128.29
A1	SWG2A1-BRANDED	£222.50	£196.43

PRICE EACH

Optional spare panels

Poster size	Code	1+	5+
A2	SWG2A2-PANEL	£52.49	£48.99
A1	SWG2A1-PANEL	£73.75	£66.58

PRICE EACH



Easy change poster cover

BRAND your product

WPG6 HEAVY DUTY PAVEMENT SIGN

- Heavy-duty sign with strong steel frame and steel back panel
- Robust construction to withstand weather
- Water-fillable base with a 30 litre capacity
- Designed with wheels to aid transportation
- Recessed area on header allows for optional branding
- Poster cover is magnetic for easy updates

Without branded header

Poster size	Code	1+	5+
A1	WPG6A1	£268.00	£249.00
A0	WPG6A0	£461.00	£425.00
40" W x 60" H	WPG664	£510.00	£475.00

PRICE EACH

With branded header

Poster size	Code	1+	5+
A1	WPG6A1-BRANDED	£315.04	£280.57
A0	WPG6A0-BRANDED	£507.78	£456.91
40" W x 60" H	WPG664-BRANDED	£556.00	£507.00

PRICE EACH



Built-in wheels for easy positioning



Header panel for branding

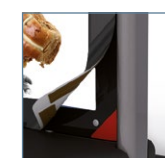

Magnetic covers for easy poster change



Now available in 40" x 60" poster size





**ABC8 TALL THIN CHALKBOARD SANDWICH BOARD**

NEW



Branded header available



- Chalkboard Sandwich Board with a narrow design
- Add branded headers if required
- Double-sided design with stylish stainless steel hinges
- Water-resistant material that is suitable for outdoor use
- Total size: 400mm W x 1320mm H

Print	Visual area (W x H)	Code	1+	10+
Unbranded	400mm x 1220mm	ABC8K132	£95.00	£92.00
Branded	400mm x 1220mm	ABC8K132-BRANDED	£155.00	£150.00

PRICE EACH – Other sizes and finishes manufactured on request.

**ABC7 WOODEN CHALKBOARD A BOARD WITH POSTER HOLDER**



ABC7



ABC7K

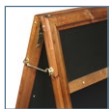

Hinged for compact storage



Quick and easy poster change

- A board with chalkboard and poster holder
- Features a chalkboard header with custom branding available
- Double-sided design helps to boost footfall
- Built with brass latches and hinges for easy foldaway storage
- Designed with a premium 65mm thick frame in dark oak or black finish
- Update using liquid chalk pens or insert A1 or A2 size posters
- Overall size (A2): 555mm x 1000mm
- Overall size (A1): 735mm x 1300mm

**Without branding**

Size	Colour	Code	1+	5+
A2	Dark oak	ABC7A2	£98.75	£92.34
A1	Dark oak	ABC7A1	£209.00	£199.00
A2	Black	ABC7KA2	£98.75	£92.34
A1	Black	ABC7KA1	£180.00	£171.86

PRICE EACH



**ABC4 CHALKBOARD A BOARD**



- Solid wooden A board with a dark oak frame
- Double-sided design to help boost footfall
- Built with hinges for easy foldaway storage
- Designed with a 40mm x 20mm frame
- Update using liquid chalk pens
- Available in two overall sizes:  
460mm W x 800mm H  
660mm W x 1000mm H

FROM  
**£45.80**

Visual area (W x H)	Code	1+	5+
365mm x 565mm	ABC4A2	£48.00	£45.80
565mm x 765mm	ABC4A1	£67.32	£64.74

PRICE EACH – Other sizes and finishes available on request.



Don't forget you will need...

**Chalk Pens**

visit page 64 for our chalk pen range





## ABC6 WOODEN A BOARD POSTER HOLDER

BEST SELLER



Oak



Magnetic poster cover



Hinged for compact storage



- Versatile A1 A board with a chalkboard and poster facility
- Alternate between printed posters or liquid chalk pen displays
- Designed with a magnetic flip cover on both sides
- Built-in hinges allow for folding compact storage
- Finished with a classic dark oak or black stain for a rustic aesthetic
- Manufactured from solid wood with a 40mm x 40mm frame
- Visual area: 575mm W x 820mm H
- Overall size: 710mm W x 1150mm H

### Without printed poster

Poster Size	Colour	Code	1+	5+
A1	Oak	ABC6A1	£179.87	£173.53
A1	Black	ABC6A1K	£179.87	£173.53

PRICE EACH – Other sizes available on request.

### With printed poster

Poster Size	Colour	Code	1+	5+
A1	Oak	ABC6A1-PRINTED	£223.71	£190.16
A1	Black	ABC6A1K-PRINTED	£223.71	£190.16

PRICE EACH – Other sizes available on request.

## Chalkboard branding service

Brand a selected area of your product with your chosen graphic, or brand your whole chalkboard with a full colour vinyl print of your artwork.

visit [www.ukpos.com](http://www.ukpos.com) or call 0161 516 2467



## ABCSQK CHALKBOARD A BOARD BLACK



- Double-sided chalkboard A board with black frame
- Designed with a scratch-resistant and UV-resistant surface
- Thick wooden frame with strong metal hinges
- Update with liquid chalk pens

**BRAND**  
your product

Visual area (W x H)	Code	1+	5+
475mm x 670mm	ABCSQKA2	£55.95	£53.60
580mm x 880mm	ABCSQKA1	£90.79	£86.96

PRICE EACH

## ABC5 SNAP FRAME WOODEN CHALK A BOARD



- Solid wooden A board with a dark oak frame
- Includes a snap frame on either side for poster displays
- Update using liquid chalk pens



Includes built-in chalkboard



### Without branded header

Poster size	Code	1+	5+
A1	ABC5A1	£179.90	£172.56

PRICE EACH – Other sizes and finishes manufactured on request.

### With double sided branded header

Poster size	Code	1+	5+
A1	ABC5A1-BRANDED	£219.88	£211.46

PRICE EACH – Other sizes and finishes manufactured on request.

## ABC2 A1 CHALKBOARD A BOARD



- Solid wooden A board with a dark oak frame
- Double-sided design to help boost footfall
- Built with hinges for easy foldaway storage
- Designed with a premium 40mm x 40mm frame
- Update using liquid chalk pens
- Overall size: 650mm W x 1100mm H

### Without printed vinyl graphics

Visual area (W x H)	Code	1+	5+
570mm x 770mm	ABC2A1	£85.00	£78.75

PRICE EACH

### With two printed vinyl graphics

Visual area (W x H)	Code	1+	5+
570mm x 770mm	ABC2A1-BRANDED	£147.00	£130.75

PRICE EACH

## ABC3 REVERSIBLE CHALKBOARD A BOARD



- Curved-top wooden A board with a dark oak frame
- Reversible boards can be removed from the top
- Update with liquid chalk pens



Removable panels



### Without branded header

Visual area (W x H)	Code	1+	5+
420mm x 600mm	ABC3A2	£82.00	£74.00
570mm x 885mm	ABC3A1	£94.00	£89.00

PRICE EACH – Other sizes and finishes available on request.

### With double sided branded header

Visual area (W x H)	Code	1+	5+
420mm x 600mm	ABC3A2-BRANDED	£129.00	£116.00
570mm x 885mm	ABC3A1-BRANDED	£156.00	£141.00

PRICE EACH – Other sizes and finishes available on request.





Our slimline premium Digital Totem is a freestanding, single-sided digital advertising board. Available with a choice of 43" or 55" displays, our Digital Totem has built-in speakers and easy access to USB. Our units are perfect for use in airports, retail, hospitality, leisure and many more industries.



5mm anti-shatter tempered glass



Easy access to USB and HDMI ports

## DDT Digital Display Totem

With the built-in USB 2.0 port, uploading your content on our Digital Display Totem couldn't be easier. Simply create your content on a computer, save the files to a USB stick and insert the stick into the unit's USB port.



- 43" and 55" Digital Display Totems perfect for department stores, airports, banks and hotels
- Display image or video slideshows or both via split-screen
- Single-sided display with built-in speakers and screen finished with tempered glass
- Available with optional wheels and branding
- Upload images and videos using the USB port
- Built-in 8GB memory to store graphics for future use
- Designed for indoor use with a mains-powered adapter
- Shipped by pallet for extra protection
- Manufactured with a high-quality aluminium frame
- Max resolution: 1920 x 1080 pixels
- Total size (H x W x D):
- 43": 64cm W x 184cm H x 6cm D
- 55": 76cm W x 190cm H x 6cm D

Colour	Screen Size	Code	1+	5+
Black	43"	DDT01K	£1,432.05	£1,350.16
White	43"	DDT01W	£1,432.05	£1,350.16
Black	55"	DDT-55K	£1,987.68	£1,932.46

PRICE EACH



## DDV Touchscreen Digital Display Totem

Our Totems also come with the option of touchscreen. You can update your images or videos either via USB or via the Android operating system, which allows you to install your choice of applications.



- Interactive touchscreen for your point of sale
- Perfect for department stores, airports, banks and hotels
- Single-sided digital display available in either black or white with built-in speakers
- Finished with tempered glass to protect the screen
- Features Android operating system so you can upload your own apps
- Designed for indoor use with a mains-powered adapter
- Shipped by pallet for extra protection
- Manufactured with a high-quality aluminium frame
- Max resolution: 1920 x 1080 pixels
- 64cm W x 184cm H x 6cm D

Colour	Screen Size	Code	1+	5+
Black	43"	DDV-43KT	£2,063.29	£1,939.49
White	43"	DDV-43WT	£2,063.29	£1,939.49

PRICE EACH







Full HD  
1080p

USB  
Copy from USB

**DIGINI™**  
DIGITAL DISPLAYS



Fold away hinges for compact storage

**BRAND**  
your product

**DAB02 DIGITAL A BOARD**

- Premium digital A board display for high-quality graphics
- Perfect for department stores, airports, banks and hotels
- Single-sided premium digital display with built-in speakers
- Includes a 43" LED-backlit screen for ultra-clear viewing
- Finished with anti-shatter and dustproof tempered glass to protect the LG HD screen
- Supports a number of file formats
- Built-in 8GB memory to store graphics for future use
- Can display videos, images and presentations
- Hinged legs for easy storage
- Designed for indoor use with a mains-powered adapter
- Manufactured with a powder-coated mild steel frame
- Max resolution: 1920 x 1080 pixels full HD 16:9
- Display area: 526mm W x 938mm H
- Overall size: 610mm W x 1580mm H x 40mm D
- Delivered palletised for protection

Colour	Code	1+	5+
Black	DAB02K	£1,092.75	£1,059.91
White	DAB02W	£1,092.75	£1,059.91

PRICE EACH



For our extensive full range of digital and LED products visit [www.ukpos.com](http://www.ukpos.com)



Full HD  
1080p

USB  
Copy from USB

**DDW WALL MOUNTED DIGITAL ADVERTISING SCREEN**

- Upload images and videos using the USB port
- Single-sided display with built-in audio, video and image ability
- Split-screen capability
- Can be used portrait or landscape
- Available with 32" or 43" HD LCD panel with LED backlight
- Built-in 8GB storage
- Easy access to USB and HDMI ports
- Max resolution: 1920 x 1080 pixels
- 32" display area: 700mm x 390mm
- 43" display area: 940mm x 530mm

Size	Code	1+	5+
32"	DDW-32K	£944.99	£889.99
43"	DDW-43K	£1,494.59	£1,404.01

PRICE EACH



Easy-to-operate digital display board



HD LCD screen with rounded corners and LED backlight

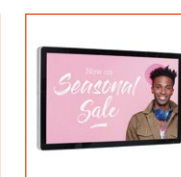

Screen can be portrait or landscape

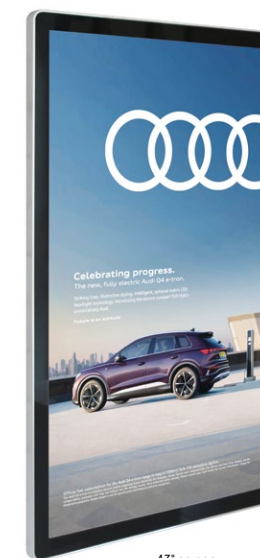

43" screen



32" screen

**DIGINI™**  
DIGITAL DISPLAYS



TTC MINI TABLETOP CHALKBOARD



- Double-sided display ideal for table numbers, offers or notices
- Securely fitted to the light oak base
- High-pressure laminate chalkboard provides an easy clean writing surface

Size	Code	1+	10+
A8	TTCA8	£1.94	£1.85
A7	TTCA7	£2.90	£2.80

PRICE EACH

CH01 WOODEN CONDIMENT HOLDER

NEW



Code	1+	10+
CH01	£14.50	£13.95

PRICE EACH

- Wooden condiment holder for use in the hospitality sector
- Keeps condiments and cutlery neatly stored
- Dark oak finish will suit a wide variety of decors
- External size: 200mm W x 185mm H x 155mm D

CLP WOODEN CLIPBOARD



Size	Code	1+	10+
A5	CLP01	£7.72	£6.98
A4	CLP02	£8.78	£7.98

PRICE EACH – Other sizes manufactured on request.

- Wooden clipboards, ideal for food and drink menus
- Choice of dark oak or dark stain finish
- Clearly attach menus, forms or information sheets with the clip
- Manufactured from 4mm birch plywood for a smooth writing surface
- Available in two sizes:  
A5 overall size: 175mm W x 240mm H  
A4 overall size: 240mm W x 340mm H

CKP LIQUID CHALK PENS



Nib size	Type	Pack qty.	Code	Price
5mm (thin)	White	3	CKPW053	£9.90
15mm (thick)	White	3	CKPW153	£12.93
5mm (thin)	Assorted	5	CKPA055	£14.14
15mm (thick)	Assorted	5	CKPA155	£22.50
N/A	Eraser	1	CKP-ERASER	£7.63

PRICE PER PACK

- Use liquid chalk pens to create colourful standout messages
- Choose between thin (5mm) and thick (15mm) nibs
- Ideal for use on all of our chalkboards
- Easily cleanable with a damp cloth
- Not recommended for outdoor use



TTB TABLE TOP CHALKBOARD



- Freestanding double-sided display with a dark oak base
- Ideal for promoting offers and events on tabletops
- A4 size is also available with a top cut out handle
- HPL board provides an easy-clean surface
- Designed for use with liquid chalk pens



FROM £5.40

Without handle

Size	Code	1+	10+
A5	TTBA5	£5.90	£5.40
A4	TTBA4	£6.95	£6.47
A3	TTBA3	£10.40	£9.50

PRICE EACH – Custom printing available.

With handle

Size	Code	1+	10+
A4	TTBA4H	£6.95	£6.47

PRICE EACH – Custom printing available.



CBS1/CBS2 LEAN BACK CHALKBOARD



- Miniature tabletop chalkboard for displaying prices and promotions
- Ideal for displaying menus and offers on bars and tabletops
- Smooth acrylic matte finish provides an easy writing surface
- Update using our liquid chalk pens
- Manufactured from 3mm thick black acrylic



FROM £1.16

CBS1 – portrait

Size	Code	1+	25+	100+	500+
A8	CBS1A8	£1.72	£1.36	£1.28	£1.16
A7	CBS1A7	£1.89	£1.64	£1.54	£1.34
A6	CBS1A6	£2.55	£2.15	£1.97	£1.81
A5	CBS1A5	£3.81	£3.52	£3.19	£2.91
A4	CBS1A4	£5.33	£5.02	£4.72	£4.62

PRICE EACH

CBS2 – landscape

Size	Code	1+	25+	100+	500+
A8	CBS2A8	£1.77	£1.46	£1.31	£1.17
A7	CBS2A7	£1.92	£1.65	£1.57	£1.38
A6	CBS2A6	£2.55	£2.18	£2.03	£1.80

PRICE EACH

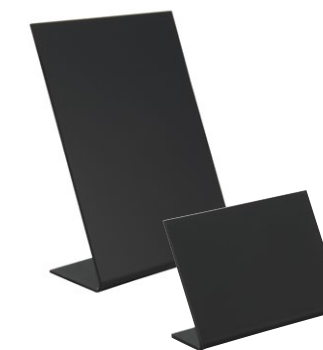



CBU UNFRAMED CHALKBOARD



- Simple double-sided chalkboard for internal or external use
- Use on their own or place in a frame
- Display in either portrait or landscape
- Update using liquid chalk pens
- Manufactured from 6mm moisture-resistant melamine

Overall Size (mm)	Code	1+	10+
300 x 420	CBUA3	£8.91	£7.53
420 x 600	CBUA2	£16.35	£13.98
600 x 840	CBUA1	£21.16	£18.10
800 x 1220	CBUA0	£28.79	£27.62

PRICE EACH – Other sizes available on request.

CWF DARK WOOD FRAMED CHALKBOARD



FROM  
**£6.50**

- Chalkboard with thick 40mm dark wood frame to create a rustic aesthetic
- Ideal for promoting offers or events in restaurants, cafes and bars
- Use with liquid chalk pens which wipes clean in seconds
- Add a pack of adhesive pads for wall mounting if required

Size (mm)	Code	1+	5+
A3 (420 W x 300 H)	CWFA3	£7.10	£6.50
A2 (590 W x 420 H)	CWFA2	£9.80	£9.15
A1 (840 W x 590 H)	CWFA1	£14.23	£13.36

PRICE EACH – Other sizes manufactured on request.

PFG16 WOOD EFFECT 25MM SNAP FRAME



- Wood-effect poster frame with 25mm profile
- Create rustic and natural-looking poster displays
- Front-opening mechanism for easy and quick updates
- Includes a UV anti-glare protective cover
- Pre-drilled styrene back panel for instant mounting
- Add custom-printed posters if required

Size	Code	1+	10+
A4	PFG16A4	£8.65	£7.80
A3	PFG16A3	£12.86	£10.95
A2	PFG16A2	£18.45	£15.86
A1	PFG16A1	£27.61	£23.67

PRICE EACH

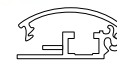

25mm profile



SA14 CHALKBOARD INSERTS



- Transform your display with a chalkboard insert
- Ideal for use with show card frames or snap frames
- Can be updated using liquid chalk pens
- Wipes clean in seconds
- Manufactured from 1mm polypropylene

Size	Code	Price
A5	SA14A5	£1.16
A4	SA14A4	£2.08
A3	SA14A3	£3.69
A2	SA14A2	£7.67
A1	SA14A1	£13.85

PRICE EACH – Other sizes manufactured on request.







EAS04/EAS05/EAS06 FREESTANDING WOODEN EASELS



Without chalkboard

Finish	Code	1+	5+
Dark Oak	EAS04	£44.00	£38.50
White	EAS05	£55.77	£48.77
Black	EAS06	£55.77	£48.77

PRICE EACH

With plain A1 chalkboard

Finish	Code	1+	5+
Dark Oak	EAS04C	£64.86	£56.60
White	EAS05C	£76.93	£66.87
Black	EAS06C	£76.93	£66.87

PRICE EACH

With branded A1 chalkboard

Finish	Code	1+	5+
Dark Oak	EAS04C-BRANDED	£81.16	£71.46
White	EAS05C-BRANDED	£97.43	£82.73
Black	EAS06C-BRANDED	£97.43	£82.73

PRICE EACH

With printed A1 foam board

Finish	Code	1+	5+
Dark Oak	EAS04F-PRINTED	£71.34	£62.43
White	EAS05F-PRINTED	£83.25	£72.68
Black	EAS06F-PRINTED	£83.25	£72.68

PRICE EACH



Black  
EAS06



White  
EAS05

FROM  
**£38.50**



Dark Oak  
EAS04

- Large easel for displaying creative chalkboard or canvas displays
- Perfect for catching attention and promoting offers
- Finished in dark oak, black or white to suit your brand
- 7mm shelf groove holds canvases or boards up to 6mm thick
- Supports boards up to and including A0 size
- Add a printed chalkboard, Foamex board, or a plain chalkboard if required
- For indoor use only
- Overall size: 600mm W x 1650mm H



EASC COLLAPSIBLE WOOD EASEL



- Portable easel for events, retailers or exhibitions
- Lightweight design with high-quality extension and locking system
- Designed with a top clamp with three resting ledges for stability
- Supports canvases or Foamex panels up to A1 size
- Adjustable up to 6ft
- Manufactured from pine wood
- Collapsible compact design for easy transportation and storage
- Overall size when open: 880mm W x 1830mm H x 880mm D

Code	Price
EASC01	£18.45

PRICE EACH

FROM  
**£18.45**



Collapsible design

EAS03 A FRAME WOODEN EASEL WITH CLAMP



- Large easel designed for use with chalkboards or canvases
- Includes a top clamp to secure your display
- Both the height and angle are adjustable
- Folds flat for compact storage
- Supports boards up to and including A0 size
- Manufactured from hardwood
- Overall size (when easel is fully extended): 550mm W x 1960mm H x 620mm D
- Adjustable height range: 1460mm - 1960mm
- Shelf width: 480mm

Code	1+	5+
EAS03	£49.53	£45.86

PRICE EACH

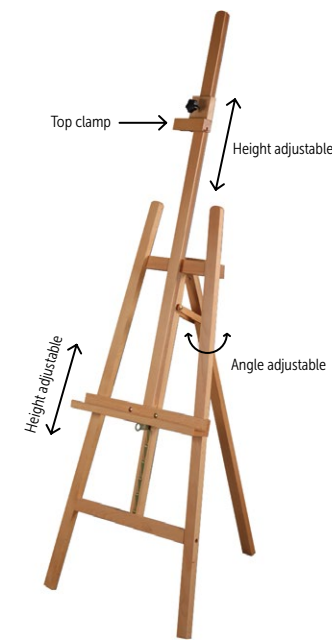
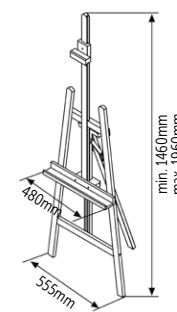



### CD9 THREE TIER LEAFLET HOLDER PORTRAIT COUNTER STANDING

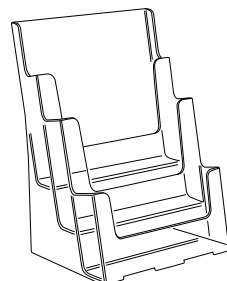

A4 | CD9

- Three tier counter-standing leaflet holder
- Manufactured from clear styrene
- 1/3 A4 (third A4) | CD12  
Holds 1/3 A4 (third A4) literature  
Internal size: 104mm W x 140mm H x 35mm D
- A5 | CD10  
Holds A5 literature up to 155mm wide  
Internal size: 155mm W x 195mm H x 35mm D
- A4 | CD9  
Holds A4 literature  
Internal size: 220mm W x 292mm H x 35mm D

Single tier

Size	Code	1+	10+	100+	500+
1/3 A4 (third A4)	CD12	£4.02	£3.34	£2.65	£2.46
A5	CD10A	£4.57	£4.19	£3.17	£2.98
A4	CD9	£10.29	£8.49	£7.49	£6.98

PRICE EACH

### CF20 COUNTER STANDING LANDSCAPE LEAFLET HOLDER

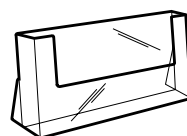

A4 | CF20

- Landscape counter-standing leaflet holder
- Manufactured from clear styrene
- Holds A4 literature up to 328mm wide
- Internal size: 330mm W x 190mm H x 32mm D

Single tier

Size	Code	1+	10+	100+	500+
A4	CF20	£4.58	£3.75	£3.48	£3.28

PRICE EACH

Other sizes available at [www.ukpos.com](http://www.ukpos.com)

### CD5 BUSINESS CARD HOLDER LANDSCAPE COUNTER STANDING



- Business card holder for countertops
- Designed with a stylish curved edge
- Choose between a black or clear holder
- Features a foot at the rear for added stability
- Manufactured from styrene
- Internal size: 89mm W x 20mm D
- External size: 97mm W x 48mm H x 32mm D

FROM **£0.37**

Single tier

Colour	Code	1+	10+	100+	500+
Clear	CD5	£0.74	£0.54	£0.40	£0.37
Black	CD5K	£0.74	£0.54	£0.40	£0.37

PRICE EACH

### Bring your brand to life

Add your company logo, slogan or message to our range of leaflet dispensers.

For more information visit [www.ukpos.com](http://www.ukpos.com)



FROM **£0.85**

### CD3 LEAFLET HOLDER PORTRAIT COUNTER STANDING



- Counter-standing leaflet holder
- Manufactured from clear styrene
- 1/3 A4 (third A4) | CD4  
Holds 1/3 A4 (third A4) literature up to 102mm wide  
Internal size: 105mm W x 200mm H x 35mm D
- A6 | CD110  
Holds A6 literature up to 108mm wide  
Internal size: 125mm W x 115mm H x 38mm D
- A5 | CD3  
Holds A5 literature up to 155mm wide  
Internal size: 156mm W x 200mm H x 35mm D
- A4 | CD1  
Holds A4 literature up to 215mm wide  
Internal size: 214mm W x 296mm H x 32mm D

Single tier

Size	Code	1+	10+	50+	100+	500+
1/3 A4 (third A4)	CD4	£1.19	£1.14	£0.99	£0.91	£0.85
A6	CD110	£1.89	£1.55	£1.43	£1.32	£1.25
A5	CD3	£1.62	£1.49	£1.43	£1.38	£1.37
A4	CD1	£2.74	£2.65	£2.31	£2.10	£1.95

PRICE EACH



A5 | CD3



A6 | CD110



1/3 A4 (third A4) | CD4



A4 | CD1

For our full range of Extra Capacity Leaflet Holders visit [www.ukpos.com](http://www.ukpos.com)





**SDD ACRYLIC OUTDOOR LEAFLET HOLDER WALL MOUNTED**

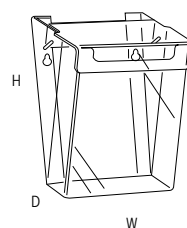

- Wall-mounted portrait leaflet holder for outdoor use
- Easily attach to your walls using the pre-drilled fixing holes
- Designed with an auto-shut lid to protect inserts
- Manufactured from clear acrylic
- Internal dimensions:  
SDD7 - 1/3 A4 (third A4): 105mm W x 220mm H x 35mm D  
SDD6 - A5: 155mm W x 220mm H x 35mm D  
SDD5 - A4: 215mm W x 310mm H x 40mm D

Single tier				
Size	Code	1+	10+	
1/3 A4 (third A4)	SDD7	£19.25	£15.50	
A5	SDD6	£21.55	£17.10	
A4	SDD5	£27.85	£26.60	
PRICE EACH				

**WD5 BUSINESS CARD HOLDER LANDSCAPE WALL MOUNTED**

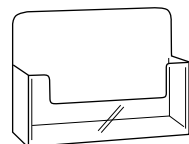

- Wall-mounted business card holder
- Attach to clean flat wall surfaces using adhesive
- Manufactured from clear styrene
- 97mm W x 58mm H x 28mm D

Available with adhesive foam pads for easy wall mounting visit [www.ukpos.com](http://www.ukpos.com)

Single tier				
Code	1+	10+	100+	500+
WD5	£0.93	£0.72	£0.57	£0.51
PRICE EACH				

**MRW WOODEN WALL MOUNTED MAGAZINE RACK**

NEW

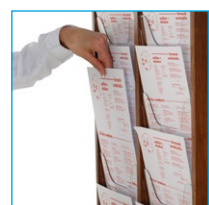

- Wooden Wall Mounted Magazine Rack with a dark or light wooden frame
- Choose between five or ten A4 pockets
- Saves valuable floor space to make smaller or busy rooms feel more spacious
- Comes with screws for easy installation
- Overall size (five pocket rack): 265mm W x 966mm H x 75mm D
- Overall size (ten pocket rack): 520mm W x 966mm H x 75mm D

Colour	No. of pockets	Code	1+	10+
Dark Wood	5	MRW-5D	£50.56	£43.20
Light Wood	5	MRW-5L	£50.56	£43.20
Dark Wood	10	MRW-10D	£76.50	£69.50
Light Wood	10	MRW-10L	£76.50	£69.50
PRICE EACH				

**WD1 LEAFLET HOLDER PORTRAIT WALL MOUNTED**



- Wall-mounted leaflet holder with pre-drilled fixing holes
- Manufactured from clear styrene

• **1/3 A4 (third A4) | WD4**  
Holds 1/3 A4 (third A4) literature up to 102mm wide  
Internal size: 105mm W x 160mm H x 35mm D

• **A6 | WD10**  
Holds A6 literature up to 109mm wide  
Internal size: 110mm W x 115mm H x 34mm D

• **A5 | WD3**  
Holds A5 literature up to 152mm wide  
Internal size: 155mm W x 160mm H x 35mm D

• **A4 | WD1**  
Holds A4 literature  
Internal size: 224mm W x 244mm H x 33mm D

Single tier					
Size	Code	1+	10+	100+	500+
1/3 A4 (third A4)	WD4	£1.69	£1.34	£1.14	£0.92
A6	WD10	£2.45	£2.02	£1.93	£1.81
A5	WD3	£1.90	£1.63	£1.28	£1.20
A4	WD1	£3.22	£2.59	£2.27	£2.09
PRICE EACH					

Available to buy with adhesive foam pads for easy wall mounting at [www.ukpos.com](http://www.ukpos.com)



1/3 A4 (third A4) | WD4

A6 | WD10

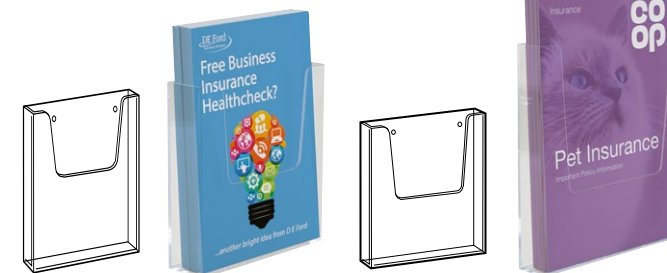

A5 | WD3

A4 | WD1



### FD80 COLLAPSIBLE BROCHURE HOLDER

- Double-sided brochure stand with six A4 shelves
- Three shelves on each side of the stand
- Fully collapsible for easy transportation
- Supplied with a heavy-duty case
- Individual shelf size: 250mm W x 300mm H
- Overall size: 253mm W x 1540mm H x 350mm D



Code	1+	5+
FD80	£79.00	£68.00

PRICE EACH

FROM **£68.00**

Includes case



### FD85 COLLAPSIBLE BROCHURE STAND

- Brochure display stand ideal for events due to the collapsible design
- Five tier design showcases all of your A4 portrait literature
- Manufactured from aluminium with clear polycarbonate pockets
- Overall size: 260mm W x 1345mm H x 350mm D



Code	1+	5+
FD85	£92.40	£79.00

PRICE EACH



### FD61 FREESTANDING LEAFLET POSTER DISPLAY



- Customisable display stand with dispensers and frames
- Choose between a single or double-sided poster stand
- Two channel profile creates a double-sided display
- Silver steel shelf supports two A4 portrait brochures
- Snap frame displays A1 posters
- Add custom-printed posters if required
- Overall size: 640mm W x 1850mm H x 450mm D

Format	Code	1+	5+
Single sided	FD61S	£130.90	£115.00
Double sided	FD61D	£173.80	£146.00

PRICE EACH

#### Variations using two channel profile

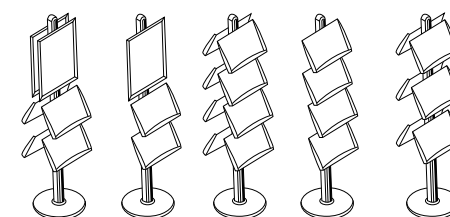

Quick easy poster change



### FD4 FREESTANDING LEAFLET DISPENSER WITH TIERS



- Freestanding leaflet display with multiple tiers
- Tiered design will help boost visibility of literature
- Manufactured from clear styrene with an aluminium pole and base
- Tier size:
  - A5 4 tier - 160mm W x 280mm H x 195mm D
  - A5 3 tier - 160mm W x 230mm H x 155mm D
  - A4 4 tier - 237mm W x 340mm H x 175mm D
  - A4 3 tier - 228mm W x 330mm H x 170mm D
- Overall height: 860mm freestanding



Size	Tiers	Code	1+	10+
A5	4	FD45	£51.00	£42.40
A5	3	FD44	£47.55	£42.00
A4	4	FD43	£51.00	£45.40
A4	3	FD42	£49.00	£42.36

PRICE EACH

### MAG3 TIERED MAGAZINE STAND



- Floor-standing magazine stand for A4 literature
- Designed with two or three tiers for separate publications
- Manufactured from clear 6mm acrylic
- Supplied flat packed
- Overall size (two tiers): 310mm W x 1180mm H x 400mm D
- Overall size (three tiers): 310mm W x 1280mm H x 400mm D



Colour	Tiers	Code	1+	5+
Clear	Two	MAG2	£127.08	£111.64
Clear	Three	MAG3	£164.53	£144.07

PRICE EACH – Other sizes and colours manufactured on request.



Branding available

## Products designed around you

Let our in-house experts design and manufacture products to suit your needs and price point today.

To find out more, visit our website or **CALL 0161 516 2467**







### PBP-50 ACRYLIC SUGGESTION BOX

FROM  
**£24.99**

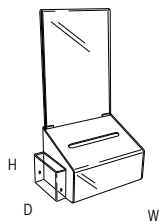

- Suggestion box for countertop or wall-mounted displays
- Includes a leaflet dispenser for 1/3 A4 literature
- Designed with an A5 or A4 poster header
- Base opens for quick access to contents
- Manufactured from high-quality white acrylic
- Overall size: 220mm W x 150mm H x 150mm D
- Slot size: 155mm L x 14mm W

Size	Colour	Code	1+	10+
A5	White	PBP-50A5	£30.29	£24.99
A4	White	PBP-50A4	£31.71	£26.60

PRICE EACH – Other sizes and colours available upon request.

### PBP-20 SMALL SUGGESTION BOX

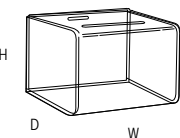
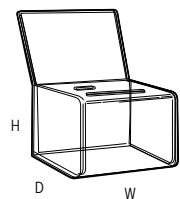

- Small collection box manufactured in impact-resistant acrylic
- Ideal for donations, competition entries, ballots and suggestions
- Available with or without a secure lock and header
- Overall size: 155mm W x 100mm H x 110mm D
- Slot size: 85mm W x 6mm H

#### Small box with header

Lock	Code	1+	10+
Without lock	PBP-20	£10.90	£9.80
With lock	PBP-20L	£13.50	£11.85

PRICE EACH

#### Small box without header

Lock	Code	1+	10+
Without lock	PBP-10	£8.11	£7.50
With lock	PBP-10L	£14.85	£11.10

PRICE EACH

### PBP-15 LARGE SUGGESTION BOX

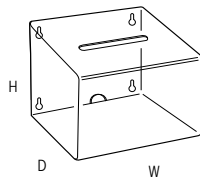
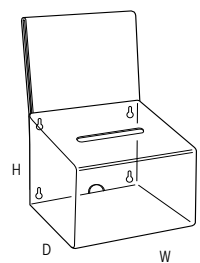

- Large clear suggestion box with optional A4 header and lock
- Can be displayed on your wall or countertop
- Manufactured from injection-moulded acrylic
- Overall size: 300mm x 240mm x 220mm

#### Large box with header

Lock	Code	1+	10+
Without lock	PBP-25	£33.58	£30.53
With lock	PBP-25L	£41.36	£37.86

PRICE EACH – Other sizes and colours available upon request.

#### Large box without header

Lock	Code	1+	10+
Without lock	PBP-15	£32.92	£25.91
With lock	PBP-15L	£40.08	£35.69

PRICE EACH – Other sizes and colours available upon request.

### PBP-60 SUGGESTION BOX WITH POSTER HOLDER

- White suggestion box with an A4 poster holder
- Available with an optional 1/3 A4, A5 or A4 side pocket
- Can be used counter standing or wall mounted
- Access the contents through the easy-access base
- Manufactured in premium white acrylic
- Overall size: 230mm W x 400mm H x 230mm D
- Slot size: 200mm L x 12mm H

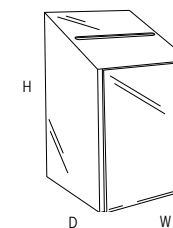

#### Suggestion box

Code	1+	10+
PBP-60	£44.01	£39.96

PRICE EACH – Other sizes and colours available upon request.

#### Suggestion box with pocket

Size	Code	1+	10+
1/3 A4 (third A4)	PBP-601/3A4	£60.06	£52.74
A5	PBP-60A5	£61.54	£53.80
A4	PBP-60A4	£62.63	£55.54

PRICE EACH – Other sizes and colours available upon request.



### PBP-30 WHITE SUGGESTION BOX

- White suggestion box manufactured from styrene
- Features a built-in A4 poster holder and A6 leaflet holder
- Easily accessible through the removable base
- Overall size: 210mm W x 300mm H x 210mm D
- Slot size: 105mm L x 6mm W

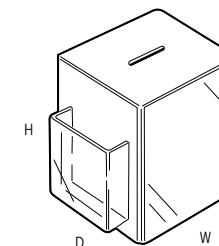

Code	1+	10+
PBP-30	£32.15	£28.17

PRICE EACH – Other sizes and colours available upon request.

### PBP-40 CARDBOARD SUGGESTION BOX (FLAT PACK)

- Cardboard suggestion box supplied flat packed
- Ideal for events or short promotional periods
- Overall size: 240mm W x 332mm H x 127mm D
- Slot size: 125mm L x 30mm W



FROM  
**£2.28**

#### Unbranded

Code	1+	10+	50+
PBP-40	£3.63	£2.97	£2.28

PRICE EACH

#### Branded

Code	5+	10+	50+
PBP-40-BRANDED	£15.00	£10.80	£7.83

PRICE EACH

**BRAND**  
your product







**PBP-80 FLOOR STANDING BALLOT BOX**

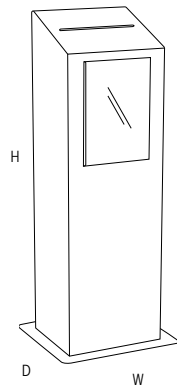

- Floor-standing ballot box for votes, opinions or reviews
- Designed with an A4 poster holder for extra branding
- Slide-opening panel provides easy access to results
- Manufactured in 5mm foamex creating a lightweight unit
- Overall size: 310mm W x 1000mm H x 255mm D
- Base size: 400mm W x 350mm D
- Slot size: 230mm L x 8mm H

Code	1+	5+
PBP-80	£116.00	£106.79

PRICE EACH – Other sizes and colours available upon request.



**SBR ROLLER BANNER FRAME**



Telescopic adjustable height



Slide-in and clamp banner fixing

- High-quality single-sided indoor banner display
- Includes a black carry case for safe transportation
- Add a custom-printed, single-sided banner if required
- Banner print area: 800mm W x 2300mm H
- Stand height adjustable from 1000mm to 2300mm
- Stand width: 800mm

**Unprinted - stand only**

Banner width (mm)	Code	1+	10+
800 W	SBR800	£82.75	£73.00

PRICE EACH

**Printed - stand and printed banner**

Banner width (mm)	Code	1+	10+
800 W	SBR800-PRINTED	£134.12	£100.80

PRICE EACH

**ERB ECONOMY ROLL UP BANNER KIT**

- Single-sided indoor banner display kit
- Designed with silver anodised feet for stability
- Includes a padded carry case for protection
- Add custom-printed banners if required
- Banner sizes available:  
800mm W x 2000mm H  
1000mm W x 2000mm H

**Unprinted - stand only**

Banner size (mm)	Code	1+	10+
800 x 2000	ERB800	£14.99	£13.30
1000 x 2000	ERB1000	£22.39	£17.98

PRICE EACH

**Printed - stand and printed banner**

Banner size (mm)	Code	1+	10+
800 x 2000	ERB800-PRINTED	£67.00	£54.79
1000 x 2000	ERB1000-PRINTED	£74.41	£59.78

PRICE EACH



**DSB PREMIUM ROLLER BANNER KIT**

- Premium banner system with two attachment methods
- Perfect single-sided banner display
- Collapses into the supplied padded bag for easy transportation
- Designed with twin twist-out feet for stability
- Indoor use only
- Banner size: 800mm W x 2000mm H

**Unprinted - stand only**

Banner size (mm)	Code	1+	10+
800 x 2000	DSB800	£19.63	£17.76

PRICE EACH

**Printed - stand and printed banner**

Banner size (mm)	Code	1+	10+
800 x 2000	DSB800-PRINTED	£72.43	£60.78

PRICE EACH

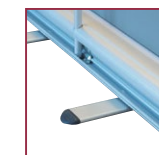

Feet for stability



Supplied with padded bag

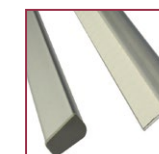

Includes two options to hold poster

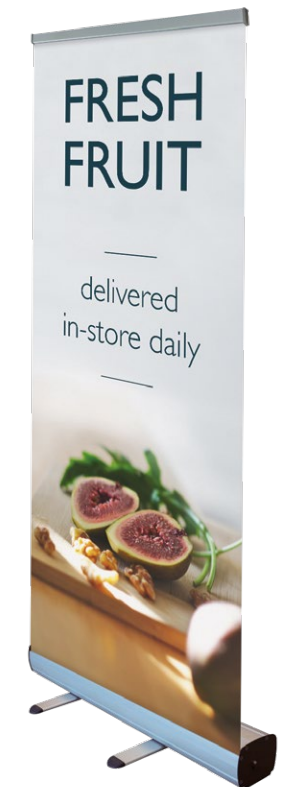



**RDD STEEL BASE BANNER HOLDER**



- Simple steel base with graphic holder for events or exhibitions
- Manufactured from powder-coated grey steel
- Base can hold a variety of rigid materials from 3mm to 40mm thick
- Maximum banner height recommended is 1500mm
- Available in four widths: 300mm, 600mm, 800mm and 1000mm
- Base depth: 350mm
- Add a single-sided 1500mm tall printed banner, manufactured from 10mm Foamex

**Base only**

Base width (mm)	Code	1+	10+
300	RDD-300	£17.50	£15.68
600	RDD-600	£31.00	£24.85
800	RDD-800	£38.28	£30.46
1000	RDD-1000	£44.53	£37.50

PRICE EACH

**Base and printed panel**

Panel width (mm)	Code	1+	10+
300	RDD300-PRINTED	£59.96	£47.50
600	RDD600-PRINTED	£105.03	£83.90
800	RDD800-PRINTED	£148.24	£116.56
1000	RDD1000-PRINTED	£182.65	£143.83

PRICE EACH



**Design Service**

We can create professional, print-ready artwork for your printed and branded products, using your images and design brief.

To find out more visit our website or **CALL 0161 516 2467**



**FG2 PRINTED FEATHER FLAG**

- Ideal for indoor or outdoor displays
- Feather design with a print of your choice
- Flags available in three heights: 2.8m, 3.4m and 4.5m
- Option to add custom-branded graphics onto one side with a mirror image on reverse
- Supplied with a water-fillable, spike or drive-on base
- Withstands winds up to approx 18mph
- Manufactured from lightweight fibreglass

**Feather flags including print**

Base type	Size	Code	1+	5+
Water fillable	2.8m	FG2-2-PRINTED	£148.50	£117.00
Water fillable	3.4m	FG2-3-PRINTED	£165.00	£126.00
Water fillable	4.5m	FG2-4-PRINTED	£203.50	£178.00

PRICE EACH



**FG3 PRINTED TEARDROP FLAG**

- Ideal for indoor or outdoor displays
- Available in a choice of 2.8m or 3.4m heights
- Teardrop shape with a print of your choice
- Printed onto one side with a mirror image on reverse
- Withstands winds up to approx 18mph
- Manufactured from lightweight fibreglass
- Supplied with a water-fillable, spike, or drive-on base



**Teardrop flags including print**

Base type	Size	Code	1+	5+
Water fillable	2.8m	FG3-2-PRINTED	£159.50	£117.00
Water fillable	3.4m	FG3-3-PRINTED	£198.00	£146.00

PRICE EACH

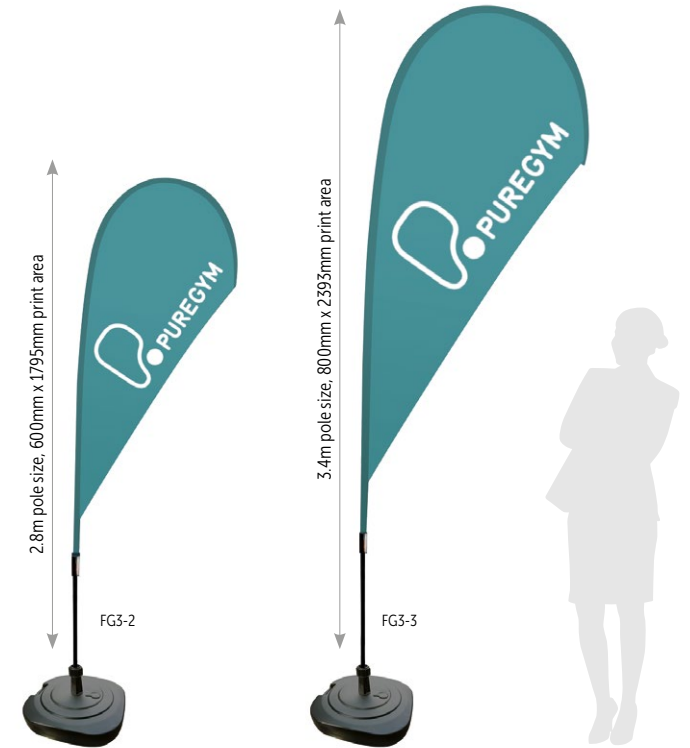





**BWH ARTIFICIAL BOXWOOD HEDGE**

- A modern and premium-quality update on standard store and café barriers
- Uplift the entrance to your café, restaurant or office space
- Mess-free and no maintenance required
- Create a vibrant display which looks great all year round
- Handmade and pre-assembled for a quick and easy solution
- Manufactured from treated plywood with weather-resistant PVC foliage
- Choose from four sizes:

- BWH01S 500mm W x 750mm H x 250mm D
- BWH01M 500mm W x 1250mm H x 250mm D
- BWH02S 1000mm W x 750mm H x 250mm D
- BWH02M 1000mm W x 1250mm H x 250mm D



BWH02S



BWH01S



BWH02M



BWH01M

Code	1+	5+
BWH01S	£175.00	£147.00
BWH01M	£215.00	£192.00
BWH02S	£215.00	£192.00
BWH02M	£299.00	£292.00

PRICE EACH

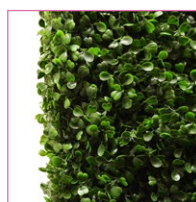

PBB - Chrome café barrier system



PBBK - Black café barrier system

**PBB-SET CHROME CAFÉ BARRIER SYSTEM**

- Create a premium outdoor seating area or manage queues
  - Heavy-duty rubber-lined 6.7kg base for a sturdy display
  - Set includes two poles and bases and two cross rails
  - Comes with spring clips to attach graphics and create tension
  - Cross rails available in three lengths: 1200mm, 1500mm and 1800mm
- Kits include:** two poles and bases and artwork on the banner

Single-sided banner complete kits

Size (mm)	Code	Colour	1+	5+
1200	PBBSET-1200-PRINTED	Chrome	£168.66	£151.10
1500	PBBSET-1500-PRINTED	Chrome	£179.86	£159.86
1800	PBBSET-1800-PRINTED	Chrome	£194.86	£174.00

PRICE PER SET

**PBBK-SET BLACK CAFÉ BARRIER SYSTEM**

- Create a premium outdoor seating area or manage queues
  - Heavy-duty rubber-lined 6.7kg base for a sturdy display
  - Set includes two poles and bases and two cross rails
  - Comes with spring clips to attach graphics and create tension
  - Cross rails available in three lengths: 1200mm, 1500mm and 1800mm
- Kits include:** two poles and bases and artwork on the banner

Single-sided banner complete kits

Size (mm)	Code	Colour	1+	5+
1200	PBBKSET-1200-PRINTED	Black	£168.66	£151.10
1500	PBBKSET-1500-PRINTED	Black	£179.86	£159.86
1800	PBBKSET-1800-PRINTED	Black	£194.86	£174.00

PRICE PER SET





**PRB1 POLE AND ROPE BARRIER**

- High-quality, durable solution for queue management
- Designed with rings to attach your chosen ropes
- Rubber-lined 6.7kg base to protect surfaces
- Modern chrome finish for a stylish system
- Height: 960mm, rope length: 1500mm, base diameter 360mm

**PRB1 – pole and base**

Code	1+	5+
PRB1	£45.00	£39.00

**PRICE PER POLE AND BASE**

**Two PRB posts with either velvet or twisted rope**

Colour	Code	1+	5+
Black Velvet	VRBK-SET	£111.00	£96.00
Red Velvet	VRBR-SET	£111.00	£96.00
Black Twisted	TRBK-SET	£114.00	£99.50
Red Twisted	TRBR-SET	£114.00	£99.50

**PRICE PER SET**

FROM  
**£39.00**



Rubber edge to protect floor



**TRB/VRB TWISTED OR VELVET ROPE FOR BARRIER SYSTEM**



TRB - Twisted rope



VRB - Velvet rope

- TRB is a high-quality cotton and polyester rope
- VRB is a high-quality velvet rope
- Create colourful barrier systems
- Designed with a weighted core
- Includes chrome end clips for easy attachment
- Length: 1500mm

Colour	Rope	Code	1+	5+
Black	Twisted	TRBK	£24.00	£22.50
Red	Twisted	TRBR	£24.00	£22.50
Black	Velvet	VRBK	£21.00	£18.00
Red	Velvet	VRBR	£21.00	£18.00

**PRICE EACH**



**RTB RETRACTABLE QUEUE BARRIER SYSTEMS**

- Retractable barrier system for controlling queues and customer flow
- Premium barrier posts in black (1000mm tall) or stainless steel (900mm tall)
- Choice of black, red or blue 2000mm long belts
- Heavy concrete-filled base
- Add-ons are available to extend the kit, including hand sanitiser dispensers and poster holders



Optional black clip on A4 poster holder



Optional silver clip on A4 poster holder



**Single pole, base and belt**

Code	Colour	1+
KRTB1	Black	£35.50
RTB1G	Silver	£35.50

**PRICE PER POLE**

**Two poles and two belts kit**

Code	Colour	1+
KRTB1-SET	Black	£71.00
RTB1G-SET	Silver	£71.00

**PRICE PER KIT**

**A4 poster holder**

Size	Code	Colour	1+	5+
A4	KRTB1-A4	Black	£19.50	£18.00
A4	RTB1G-A4	Silver	£19.50	£18.00

**PRICE EACH**





SS5



SS6



## SS5 LARGE HEAVY DUTY SHOWCARD STAND

FROM  
**£19.53**

- Our tallest showcard stand with a stylish round base
- Ideal for use next to display stands to present product information
- Frame can be used in either portrait or landscape
- Heavy steel-plated base adds stability
- Frame and clip manufactured in virtually-unbreakable plastic
- Stand height is adjustable from 1000mm - 1700mm

Size	Code	1+	10+
A4	SS5A4	£21.97	£19.53
A3	SS5A3	£24.17	£20.81

PRICE EACH

STANDARD FRAME COLOURS:



Other colours available on request.

EXTENDS TO  
1700MMEXTENDS TO  
1700MM

## SS6 HEAVY DUTY ALUMINIUM SHOWCARD STAND

- Heavy-duty stand manufactured from aluminium
- Ideal for use next to pallets to display product info
- Frame can be used portrait or landscape
- Heavy steel-plated base adds stability
- Can hold a maximum poster thickness of 4.5mm
- Stand height is adjustable from 1000mm - 1700mm

Size	Code	1+	10+
A3	SS6A3	£64.75	£54.86
A2	SS6A2	£66.41	£59.23

PRICE EACH

## SS9 LAMINATED OUTDOOR ADJUSTABLE SHOWCARD STAND



- Showcard stand for outdoor use
- Ideal for garden centres and DIY stores
- Frames can be used portrait or landscape
- Strong steel base creates a stable display stand
- Frame and clip are manufactured from virtually-unbreakable plastic
- Recommended to be used with a laminated insert
- Add custom-printed posters if required
- Height adjustable from 330mm - 510mm

Size	Code	1+	10+
A4	SS9A4	£8.90	£7.66
A3	SS9A3	£9.63	£8.31

PRICE EACH

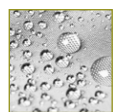
EXTENDS TO  
510MMWaterproof  
productSTANDARD FRAME  
COLOURS:Other colours available  
on request.

## SS3 SHOWCARD STAND WITH WEIGHTED COLOURED BASE



- Colourful showcard stand with an adjustable pole
- A5 - A3 sizes available
- Coloured heavy-duty base will help your display stand out
- Perfect for on-brand displays
- Frame can be used portrait or landscape
- Height adjustable from 320mm to 620mm

Size	Code	1+	10+
A5	SS3A5	£7.15	£6.76
A4	SS3A4	£7.41	£6.56
A3	SS3A3	£8.81	£7.94

PRICE EACH

EXTENDS TO  
620MM

STANDARD FRAME COLOURS:



Other colours available on request.



## SS23 ADJUSTABLE SHOWCARD STAND

- Ideal for displaying promotions or directional signage
- Choose a clear, black, white, red, blue or green frame
- Designed with a flat steel base suitable for placing under pallets
- Frame can be used portrait or landscape
- Frame and clip manufactured from virtually-unbreakable plastic
- Available with a printed poster, chalkboard insert or PVC poster sleeve
- Choose between small or large stands, both of which have an adjustable pole
- Height range (small stand): 330mm - 510mm
- Height range (large stand): 830mm - 1510mm



Printed inserts available



Clear frame available



FROM  
**£4.30**

## SMALL 330-510mm

Size	Code	1+	10+
A4	SS20A4	£4.97	£4.30
A3	SS20A3	£5.93	£5.51

PRICE EACH

## LARGE 830-1510mm

Size	Code	1+	10+
A4	SS22A4	£6.61	£5.81
A3	SS22A3	£7.35	£6.39

PRICE EACH

STANDARD FRAME COLOURS:



Other colours available on request.

EXTENDS TO  
510MMEXTENDS TO  
1510MM



## CRT WOODEN DISPLAY CRATE



- Create a rustic and natural visual display
- Ideal for shelving or window displays
- Choice of dark or light oak finish
- Manufactured from 8mm wood
- Option to add a plain chalkboard and pack of foam pads. Available online

Overall size (mm)	Finish	Code	1+	5+
230 W x 110 H x 160 D	Light Oak	CRT05	£7.65	£7.10
230 W x 110 H x 160 D	Dark Oak	CRT06	£7.65	£7.10
350 W x 210 H x 260 D	Dark Oak	CRT01	£13.45	£12.75
500 W x 260 H x 360 D	Dark Oak	CRT02	£19.86	£19.10

PRICE EACH

## CDB WHITE METAL DUMP BIN

- Increase impulse purchases in your store
- Designed with an adjustable shelf
- Manufactured from strong white nylon-coated metal
- Slots together in seconds
- Collapses for compact storage
- Available in two sizes:  
CDB43: 430mm W x 750mm H x 430mm D  
CDB62: 635mm W x 766mm H x 635mm D

Overall size (mm)	Code	1+	10+
430 sq. x 750 H	CDB43	£29.97	-
635 sq. x 766 H	CDB62	£28.27	£24.63

PRICE EACH

FROM  
**£24.63**



## CDBZ SILVER DUMP BIN

- Silver collapsible bin ideal for small items
- Help boost impulse purchases and basket size
- Adjustable shelf to suit your products
- Manufactured from metal-coated zinc
- Available in two sizes:  
Square: 567mm W x 791mm H x 561mm D  
Rectangular: 569mm W x 791mm H x 416mm D

Style	Code	1+	5+
Rectangular	CDBZ45	£34.76	£32.35
Square	CDBZ55	£53.45	-

PRICE EACH



## SS13 BASKET SHOWCARD HOLDER

- Display prices or promotions directly from your dump bin
- Help increase impulse buys
- Designed for use on any wire basket 4mm - 8mm thick
- Spring-loaded tube adjusts from 330mm - 510mm
- Suitable for portrait or landscape use
- Manufactured from virtually-unbreakable plastic

Size	Code	1+	10+
A5	SS13A5	£4.44	£3.67
A4	SS13A4	£4.46	£3.75
A3	SS13A3	£5.12	£4.32

PRICE EACH

STANDARD COLOURS:  
● ● ● ● ● ●  
Other colours available on request.



Clear frame available

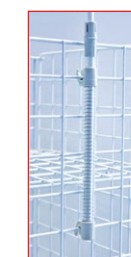



**FSB METAL CRATE DUMP MERCHANDISER**



Removable wire cage

- Freestanding wire mesh dump bin
- Manufactured in stylish black powder-coated steel
- Place commonly-bought items together e.g. crisps next to sandwiches
- Supplied flat packed for convenient transportation
- Angled header space for labels and signage
- 620mm W x 270mm D
- Adjustable height: 410mm - 670mm

Code	1+
FSB-60	£98.00
PRICE EACH – Other sizes manufactured on request.	

**WCM WOODEN CRATE DUMP MERCHISER**



- Freestanding wooden crate dump bin
- Features removable integrated wire cage with black finish
- Place commonly-bought items together e.g. crisps next to sandwiches
- Rustic pine construction with reinforced corners for durability
- Internal size: 560mm W x 210mm H x 250mm D
- External size: 640mm W x 300mm H x 340mm D

Code	1+	5+
WCM-60	£63.50	£61.50
PRICE EACH – Other sizes manufactured on request.		

**BFD SCOOP BIN FOOD DISPENSER**



18L Dispenser



Easy-clean scoop holder



Supplied with scoop



Changeable label holder

- Refillable scoop bin food dispensers made from BPA-free PCTG
- Join the zero-waste movement and make a difference
- Promote packaging-free, responsible retail practices
- Appeal to environmentally-conscious consumers
- Suitable to hold a wide range of products including sweets, nuts and cereals
- Supplied with scoop and detachable, easy-clean scoop holder
- Features a false front so that it always looks full
- Comes with a handy label holder
- Manufactured in two different sizes:  
18L: 300mm x 330mm x 330mm  
12L: 200mm x 330mm x 330mm

Size	Code	1+
12L	BFD-12	£91.78
18L	BFD-18	£132.15
PRICE EACH		

**GFDC/GFDW GRAVITY BIN FOOD DISPENSER**



- Refillable gravity bin food dispensers
- Join the zero-waste movement and make a difference
- Promote packaging-free, responsible retail practices
- BPA-free and appealing to environmentally-conscious consumers
- Suitable to hold a wide range of products including sweets, grains and pasta
- Made from PCTG
- Manufactured in three different sizes:  
13L: 100mm W x 710mm H x 350mm D  
10L: 100mm W x 570mm H x 350mm D  
6L: 100mm W x 460mm H x 350mm D

Wall mounted dispenser

Size	Code	1+
6L	GFDWN-06	£87.60
10L	GFDWN-10	£94.80
13L	GFDWN-13	£98.90
PRICE EACH		

Counter standing dispenser

Size	Code	1+
6L	GFDCN-06	£87.60
10L	GFDCN-10	£94.80
13L	GFDCN-13	£98.90
PRICE EACH		



Counter standing dispenser with base



Wall mounted dispenser with bracket



Changeable label holder



Refillable from top



**RHM WOODEN CRATE DISPLAY STAND**



- Rustic display stand with four angled crates
- Ideal for merchandising a variety of products
- Arched header ideal for branding
- Made from wood with a natural finish
- Crate size: 530mm W x 180mm H x 350mm D
- Overall size: 600mm W x 2000mm H x 540mm D

Code	1+
RHM01	£139.00

PRICE EACH



Natural wood finish



Branding available



## Brand your product

Increase your brand recognition by customising your point of sale displays with your company logo, slogan or any chosen message.

Our in-house service allows you to boost your brand awareness and grow your customers' loyalty.



To speak to our sales team call **0161 516 2467**

**AQQ FIVE SIDED DISPLAY CUBE**



- Clear display cube with one open side
- Ideal for small products or creative displays
- 75mm to 250mm sizes manufactured from clear 3mm acrylic, 300mm size manufactured from clear 4mm acrylic
- Available in a variety of stocked or bespoke sizes

Cube size	Code	1+	10+	50+
75mm	AQQ75	£7.66	£7.11	£5.74
100mm	AQQ100	£7.62	£7.02	£6.50
150mm	AQQ150	£10.99	£9.86	£8.36
200mm	AQQ200	£14.31	£12.68	£12.05
250mm	AQQ250	£19.87	£18.35	£15.94
300mm	AQQ300	£27.64	£25.09	£23.43

PRICE EACH – Other sizes manufactured on request.



**DMP-1 COUNTERTOP DUMP BIN**

- Dump bin for till areas or countertops
- Ideal for small items to increase basket size
- Manufactured from clear styrene
- Overall size: 220mm W x 215mm H x 230mm D

Code	1+	5+	10+
DMP-1	£8.90	£8.37	£8.10

PRICE EACH



**SPR CLEAR DISPLAY SPHERE**

- Stylish sphere for countertop or shelf displays
- Includes a ticket holder for prices or promos
- Manufactured in high-quality styrene
- Overall height: 210mm
- Diameter at widest point: 205mm

Code	1+	5+	10+
SPR01	£7.40	£6.70	£6.25

PRICE EACH



Ticket holder included





ADP DISPLAY PLINTH



- Create a focal point in-store with a plinth
- Ideal for retailers, exhibitions or events
- Manufactured from high-gloss 5mm and 6mm acrylic with smooth edges
- Available in various heights

Clear

Size (mm)	Code	1+	5+
300 W x 300 H x 300 D	ADP300C	£35.41	£28.86
300 W x 900 H x 300 D	ADP900C	£105.45	£95.46
300 W x 1200 H x 300 D	ADP1200C	£136.53	£123.21

PRICE EACH – Other sizes manufactured on request.

White

Size (mm)	Code	1+	5+
300 W x 600 H x 300 D	ADP600W	£97.68	£91.02
300 W x 900 H x 300 D	ADP900W	£126.54	£119.88
300 W x 1200 H x 300 D	ADP1200W	£163.17	£147.63
400 W x 900 H x 400 D	ADPL900W	£194.52	£183.51
400 W x 1200 H x 400 D	ADPL1200W	£258.69	£257.67

PRICE EACH – Other sizes manufactured on request.

Black

Size (mm)	Code	1+	5+
300 W x 600 H x 300 D	ADP600K	£97.68	£91.02
300 W x 900 H x 300 D	ADP900K	£126.54	£119.88
300 W x 1200 H x 300 D	ADP1200K	£163.17	£147.63
400 W x 900 H x 400 D	ADPL900K	£194.52	£183.51
400 W x 1200 H x 400 D	ADPL1200K	£258.69	£257.67

PRICE EACH – Other sizes manufactured on request.

ADC ACRYLIC DISPLAY CASE



- Acrylic display case for creating a focal point
- Use on its own or on top of a display plinth
- Perfect for protecting valuable products
- Manufactured from high-quality clear acrylic with a black or white base
- Available in three square sizes: 150mm, 200mm or 300mm

White base

Cube size	Code	1+	5+
150mm	ADC01W	£16.02	£15.28
200mm	ADC02W	£19.14	£18.76
300mm	ADC03W	£37.41	£34.69

PRICE EACH – Other sizes manufactured on request.

Black base

Cube size	Code	1+	5+
150mm	ADC01K	£16.02	£15.28
300mm	ADC03K	£37.41	£34.69

PRICE EACH – Other sizes manufactured on request.

AB86 ACRYLIC DISPLAY BRIDGES



- Smart and simple way to add height to your display
- Ideal for small lightweight products
- Available in a large range of sizes
- Great for creating a tiered product display
- Manufactured from 3mm or 4mm clear acrylic

50mm high

Size (mm)	Code	1+	25+	100+
50 W x 50 H x 50 D	AB8601	£1.51	£1.14	£0.95
100 W x 50 H x 100 D	AB8607	£2.06	£1.65	£1.45

PRICE EACH – Other sizes available on request.

75mm high

Size (mm)	Code	1+	25+	100+
75 W x 75 H x 75 D	AB8604	£2.05	£1.54	£1.35
150 W x 75 H x 75 D	AB8612	£2.56	£2.07	£1.73

PRICE EACH – Other sizes available on request.

100mm high

Size (mm)	Code	1+	25+	100+
100 W x 100 H x 100 D	AB8609	£2.46	£1.91	£1.68
200 W x 100 H x 100 D	AB8617	£3.76	£2.85	£2.62
200 W x 100 H x 200 D	AB8618	£5.67	£4.39	£3.79
300 W x 100 H x 150 D	AB8623	£5.42	£4.18	£3.58

PRICE EACH – Other sizes available on request.

150mm high

Size (mm)	Code	1+	25+	100+
100 W x 150 H x 100 D	AB8611	£3.14	£2.39	£2.06
150 W x 150 H x 150 D	AB8615	£4.10	£3.17	£2.94
300 W x 150 H x 200 D	AB8625	£7.15	£5.50	£4.89

PRICE EACH – Other sizes available on request.

200mm high

Size (mm)	Code	1+	25+	100+
200 W x 200 H x 100 D	AB8619	£4.94	£3.56	£3.32
200 W x 200 H x 200 D	AB8620	£8.51	£6.89	£6.11
300 W x 200 H x 300 D	AB8626	£13.16	£10.88	£10.11

PRICE EACH – Other sizes available on request.

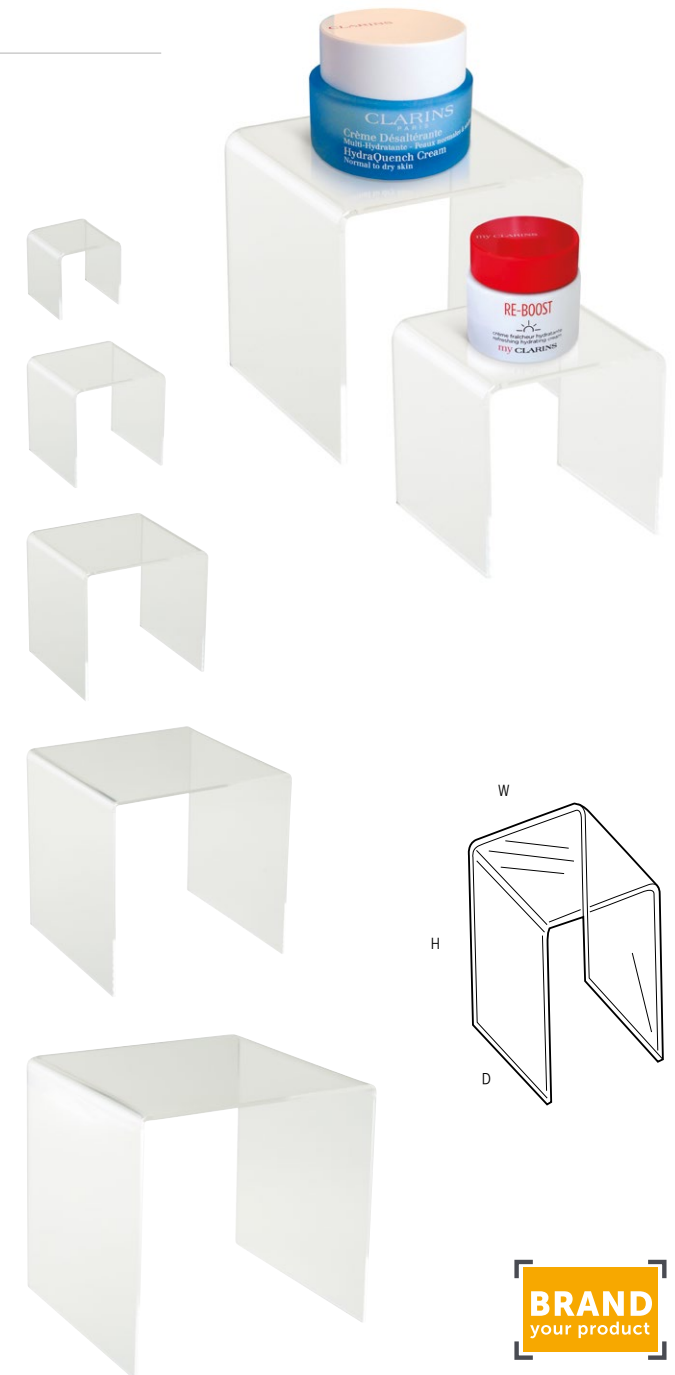

In-house bespoke product design and manufacturing

Work with our expert design team to create personalised displays and increase your brand recognition by adding your company logo, slogan or any chosen message.

For more information speak to our sales team  
CALL 0161 516 2467





## AB42 DISPLAY BRIDGE TWO TIERS



Two tier



Three tier

- Tiered Acrylic Display Bridge for countertop or shelf displays
- Ideal for smaller lightweight products and ranges
- **Two tier**  
Manufactured from high-quality 3mm acrylic and available in 2 sizes  
AB21 - 175 W x 100 H x 130 D and AB22 - 220 W x 150 H x 190 D
- **Three tier**  
Manufactured from high-quality 3mm acrylic and available in 2 sizes  
AB31 - 175 W x 150 H x 190 D and AB32 - 220 W x 230 H x 285 D
- **Four tier**  
Manufactured from high-quality 4mm acrylic  
AB42 - 300 W x 300 H x 310 D

### Clear

Size (mm)	Code	1+	25+	100+
175 W x 100 H x 130 D	AB21	£3.87	£3.63	£3.05
220 W x 150 H x 190 D	AB22	£5.74	£5.02	£4.43
175 W x 150 H x 190 D	AB31	£5.95	£5.13	£4.41
220 W x 230 H x 285 D	AB32	£8.36	£7.58	£6.61
300 W x 300 H x 310 D	AB42	£21.21	£19.32	£18.76

PRICE EACH – Other sizes manufactured on request.

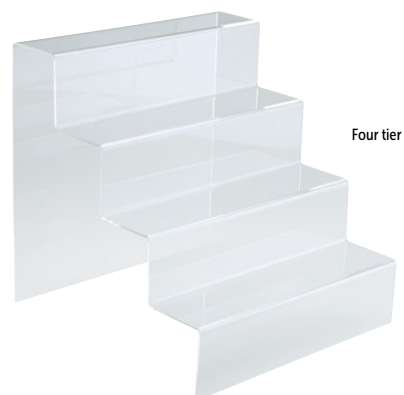

Four tier

## PES PRODUCT GLORIFIER UNIT



- Product glorifier for countertop or shelf displays
- Designed for cosmetics or small merchandise
- Ideal for making your new product stand out
- Includes a panel for A5 poster displays
- Manufactured from 3mm acrylic in black or white
- Overall size: 250mm W x 300mm H x 156mm D

Colour	Code	1+	10+	50+
White	PESA01W	£24.16	£20.60	£19.32
Black	PESA01K	£24.16	£20.60	£19.32

PRICE EACH – Other sizes manufactured on request.

## AB92 CLEAR ACRYLIC DISPLAY BLOCK



- Modern display blocks to add height to a product
- Ideal for countertops and display cabinets
- Manufactured from clear acrylic in various sizes
- Available plain, or with your personalised branding

### 20mm high

Size (mm)	Code	1+	25+	100+
50 W x 20 H x 50 D	AB9252	£2.74	£2.56	£2.34
75 W x 20 H x 75 D	AB9253	£4.39	£4.17	£3.90
100 W x 20 H x 100 D	AB9254	£6.61	£6.23	£5.84
100 W x 20 H x 150 D	AB9255	£8.69	£8.00	£7.49

PRICE EACH – Other sizes manufactured on request.

### 50mm high

Size (mm)	Code	1+	25+	100+
50 W x 50 H x 50 D	AB9273	£5.41	£4.83	£4.30
100 W x 50 H x 100 D	AB9272	£11.69	£11.05	£9.88

PRICE EACH – Other sizes manufactured on request.

### 20mm high branded

Size (mm)	Code	1+	25+	100+
50 W x 20 H x 50 D	AB9252-BRANDED	£16.36	£5.35	£4.06
75 W x 20 H x 75 D	AB9253-BRANDED	£17.85	£6.80	£5.47
100 W x 20 H x 100 D	AB9254-BRANDED	£19.85	£8.66	£7.22

PRICE EACH – Other sizes manufactured on request.

FROM  
**£2.34**

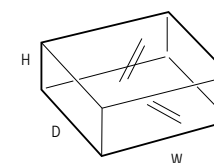

**BRAND**  
your product

### Caring for your acrylic products

Visit [www.ukpos.com](http://www.ukpos.com), to find our display cleaner spray and microfibre cloths. Product codes CLR and FBC.





NAB NESTING DISPLAY BRIDGE SET OF THREE



- Pack of three clear display bridges
- Ideal for smaller items on a countertop display
- Manufactured from clear 3mm and 4mm acrylic
- Small set overall sizes:  
130mm W x 45mm H x 50mm D  
140mm W x 60mm H x 50mm D  
150mm W x 75mm H x 50mm D
- Medium set overall sizes:  
210mm W x 100mm H x 100mm D  
220mm W x 125mm H x 100mm D  
230mm W x 150mm H x 100mm D
- Large set overall sizes:  
330mm W x 150mm H x 150mm D  
340mm W x 175mm H x 150mm D  
350mm W x 200mm H x 150mm D

PRICE PER SET OF 3				
Set size	Code	1+	25+	100+
Small	NAB1	£5.12	£4.23	£3.77
Medium	NAB2	£9.90	£8.34	£6.92
Large	NAB3	£21.83	£17.60	£14.82

Other sizes manufactured on request.

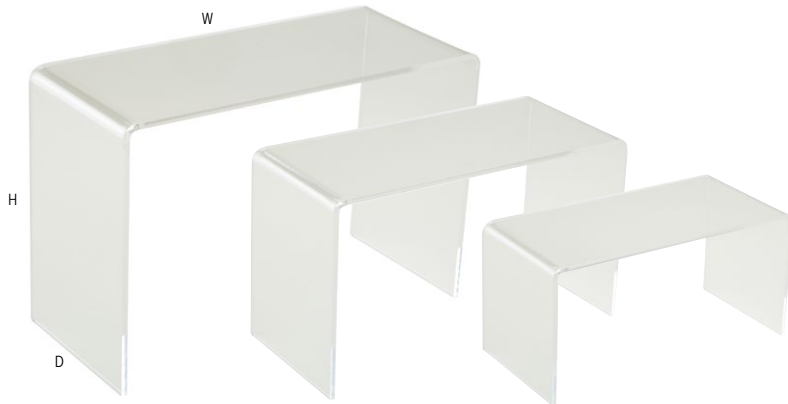

AS14 FLAT ACRYLIC BOOK STAND



FROM  
**£1.20**

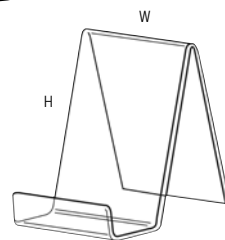

- Increase the visibility of your books, magazines or brochures
- Supports magazines, books and brochures up to 30mm thick
- Manufactured from 2mm and 3mm clear acrylic

Size (mm)	Code	1+	25+	100+
75 W x 100 H	AS14-100	£1.61	£1.39	£1.20
100 W x 150 H	AS14-150	£2.17	£1.83	£1.61
100 W x 200 H	AS14-200	£2.48	£2.10	£1.81
200 W x 250 H	AS14-250	£5.67	£4.89	£4.23

PRICE EACH – Other sizes manufactured on request.

AS15 ACRYLIC PRODUCT SUPPORT STAND



- Ideal for a variety of products including cushions, frames, books and handbags
- Features an acrylic lip to stop products slipping
- Can support items up to 50mm deep
- Manufactured from 3mm acrylic

Size (mm)	Code	1+	25+	100+
80 W x 150 H	AS15-150	£2.34	£1.88	£1.67
90 W x 200 H	AS15-200	£2.79	£2.30	£2.13
100 W x 250 H	AS15-250	£3.65	£3.12	£2.81

PRICE EACH – Other sizes manufactured on request.



AS18 BOOK STAND



- Traditional book display stand for a single unit
- Manufactured from 2mm and 3mm diamond-polished acrylic

Size (mm)	Code	1+	25+	100+
75 W x 100 H	AS18-75	£1.61	£1.34	£1.14
107 W x 160 H	AS18-107	£2.32	£1.91	£1.68
150 W x 200 H	AS18-150	£3.30	£2.72	£2.41

PRICE EACH – Other sizes manufactured on request.





## FLS FOLDING LADDER SHELF STAND WITH CHALKBOARD HEADER

NEW



- Folding Ladder Shelf Stand with a plain or branded chalkboard header
- Comes with three wooden tray shelves
- Ideal for displaying small items, such as pot plants, toiletries and gifts
- Can be folded away for easy storage when not in use
- 44cm W x 162cm H x 37cm D

With branding	Code	1+	5+
No	FLS03	£175.00	£170.00
Yes	FLS03-BRANDED	£210.00	£195.00

PRICE EACH

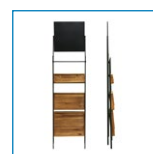

Foldable for easy storage



Branding available

**BRAND**  
your product

## WDL RUSTIC WOODEN DISPLAY LADDER

NEW



- Wooden Display Ladder with a natural rustic style
- Comes with five evenly-spaced shelves
- Ideal for window and shop floor retail displays
- Made from high-quality pine timber from a sustainable source
- 38cm W x 180cm H

Code	1+	5+
WDL5	£67.00	£64.00

PRICE EACH



## WDP WIRE DISPLAY PLINTH

- Update your visual merchandising with a wire display pedestal
- A versatile, on-trend display for a variety of products
- Can be used as a stand, for clipping items onto, or for storage
- Manufactured from mild steel wire
- Black and white colours have a lacquered finish
- Choose from three sizes:  
**Small:** 300mm W x 300mm H x 300mm D  
**Medium:** 300mm W x 600mm H x 300mm D  
**Large:** 300mm W x 870mm H x 300mm D

FROM  
**£41.59**

### Small

Finish	Code	1+	5+
Copper	WDPCS	£45.00	£41.59
White	WDPWS	£45.00	£41.59
Black	WDPKS	£45.00	£41.59

PRICE EACH – Other sizes available on request.

### Medium

Finish	Code	1+	5+
Copper	WDPCM	£49.00	£46.50
White	WDPWM	£49.00	£46.50
Black	WDPKM	£49.00	£46.50

PRICE EACH – Other sizes available on request.

### Large

Finish	Code	1+	5+
Copper	WDPCL	£55.00	£49.50
White	WDPWL	£55.00	£49.50
Black	WDPKL	£55.00	£49.50

PRICE EACH – Other sizes available on request.

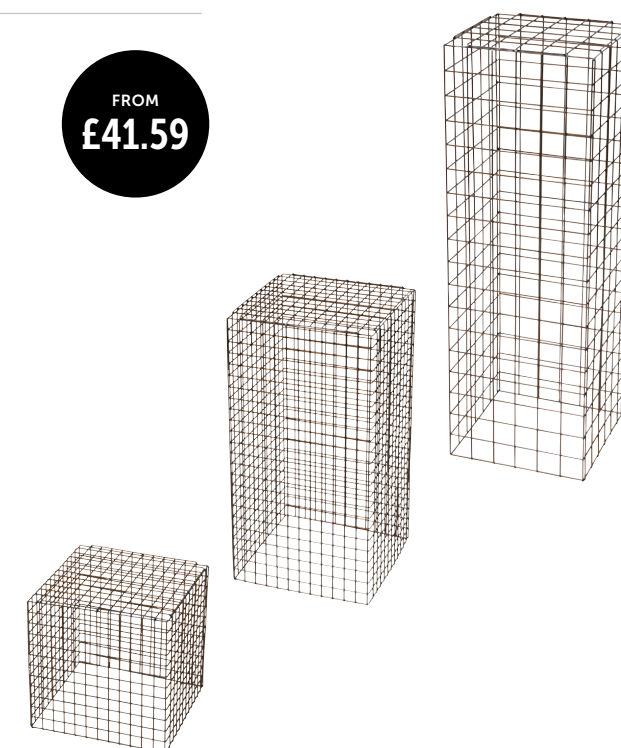

AVAILABLE IN BLACK, WHITE AND COPPER

● ○ ●  
Other colours available on request.

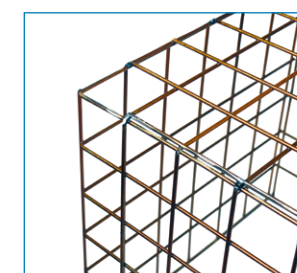



**GRD GRIDWALL MESH DISPLAY PANELS**

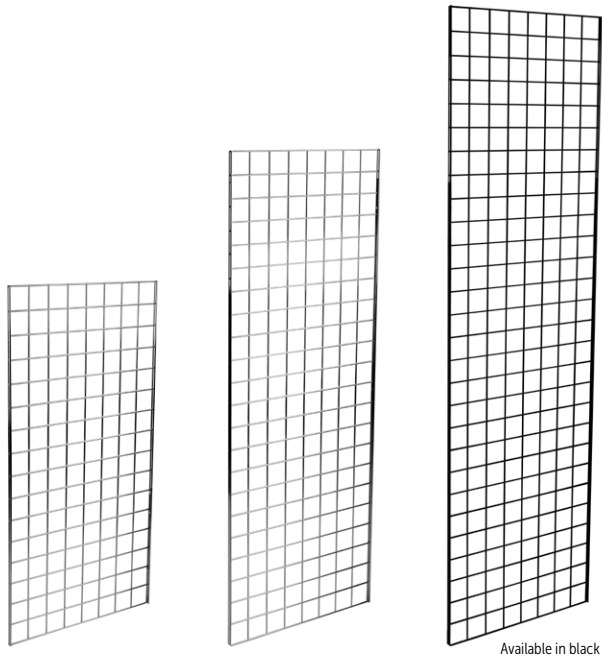

- Gridwall panels for creating an alternative to wall or slatwall displays
- Fill them with hooks, rails or shelves to display a variety of products
- Can be used with a base or mounted directly to your wall
- Manufactured from strong steel with a silver finish
- Each panel is two feet wide
- Available in five sizes: 4ft, 5ft, 6ft, 7ft and 8ft

Size	Colour	Code	1+
4ft x 2ft	Chrome	GRD4FT	£15.20
5ft x 2ft	Chrome	GRD5FT	£18.00
6ft x 2ft	Chrome	GRD6FT	£23.50
7ft x 2ft	Chrome	GRD7FT	£26.00
8ft x 2ft	Chrome	GRD8FT	£34.50
4ft x 2ft	Black	GRDK4FT	£17.50
5ft x 2ft	Black	GRDK5FT	£24.00
6ft x 2ft	Black	GRDK6FT	£26.00
7ft x 2ft	Black	GRDK7FT	£29.00
8ft x 2ft	Black	GRDK8FT	£39.00

PRICE EACH

**GRDWH FREESTANDING HEAVY DUTY SIDE SUPPORTS**

- Side supports suitable for gridwall panels up to 8ft tall
  - Heavy-duty design creates a strong and stable display
  - Creates a freestanding display unit
  - Securely holds in place the 7ft and 8ft grids
  - L shaped legs support a single-sided display, and the T shaped legs support a double-sided display
  - Manufactured from steel, supplied in pairs
- Single sided: 357mm W x 1525mm H  
Double sided: 610mm W x 1525mm H



Code	1+
GRDWH02P	£41.10
GRDWH04P	£42.00

PRICE PER SET

**GRDWS FREESTANDING STANDARD SIDE SUPPORTS**

- Lightweight side supports for use with our mesh panels
  - Creates a freestanding display unit
  - Securely holds in place any gridwall panel up to 6ft
  - L shaped legs support a single-sided display, and the T shaped legs support a double-sided display
  - Manufactured from steel, supplied in pairs
- Single sided: 306mm W x 440mm H  
Double sided: 611mm W x 455mm H

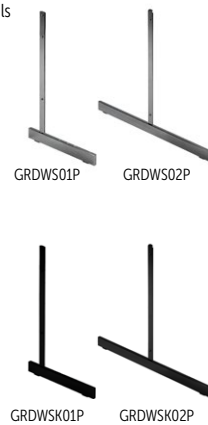

Code	Colour	1+
GRDWS01P	Chrome	£13.78
GRDWS02P	Chrome	£13.00
GRDWSK01P	Black	£14.80
GRDWSK02P	Black	£15.60

PRICE PER SET

For our full range of gridwall kits and accessories visit [www.ukpos.com](http://www.ukpos.com)

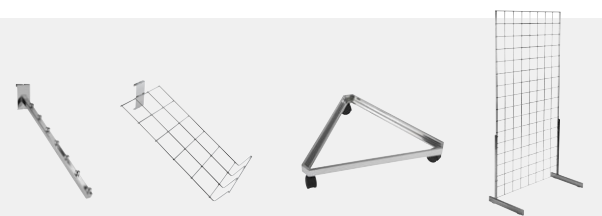

**GRDHS GRIDWALL SINGLE PRONG HOOK**

- Gridwall Single Prong Hook in a variety of lengths
- Display gifts, accessories and other small lightweight hanging items
- Hooks directly into the mesh panel
- Manufactured from strong steel with a black rubber end cap
- Available in five lengths: 100mm, 150mm, 200mm, 250mm and 300mm



Length (mm)	Colour	Code	1+
100mm	Chrome	GRDHS10	£0.49
150mm	Chrome	GRDHS15	£0.56
200mm	Chrome	GRDHS20	£0.58
250mm	Chrome	GRDHS25	£0.65
300mm	Chrome	GRDHS30	£0.74
100mm	Black	GRDHSK10	£0.60
150mm	Black	GRDHSK15	£0.64
200mm	Black	GRDHSK20	£0.70
250mm	Black	GRDHSK25	£0.72
300mm	Black	GRDHSK30	£0.77

PRICE EACH

**GRDHD GRIDWALL DOUBLE PRONG HOOK**

- Gridwall Double Prong Hook in a variety of lengths
- Ideal for merchandising hook displays on any gridwall panel
- Hooks directly into the mesh panel
- Manufactured from 5mm diameter strong steel with a chrome or black finish
- Available in five lengths: 100mm, 150mm, 200mm, 250mm and 300mm



Length (mm)	Colour	Code	1+
100mm	Chrome	GRDHD10	£1.18
150mm	Chrome	GRDHD15	£1.28
200mm	Chrome	GRDHD20	£1.31
250mm	Chrome	GRDHD25	£1.39
300mm	Chrome	GRDHD30	£1.54
100mm	Black	GRDHDK10	£0.70
150mm	Black	GRDHDK15	£0.76
200mm	Black	GRDHDK20	£0.80
250mm	Black	GRDHDK25	£0.85
300mm	Black	GRDHDK30	£0.92

PRICE EACH





WSP SLATWALL PANELS

- Slatwall panels for a fully-customisable and versatile display
- Made from 18mm thick furniture-grade melamine-faced MDF
- Each MDF panel has a 100mm pitch between grooves
- Use with slatwall inserts (WSPi) for increased durability and finished aesthetic
- Available in 1200mm x 1200mm or 300mm x 1200mm panels
- Five different finishes to choose from

FROM  
**£10.83**



1200mm x 1200mm



300mm x 1200mm

Size (mm)	Finishes	Code	1+	5+
1200 x 1200	Cream	WSP12SC	£65.23	£39.43
1200 x 1200	White	WSP12SW	£65.23	£39.43
1200 x 1200	Grey	WSP12SG	£65.23	£39.43
1200 x 1200	Black	WSP12SK	£65.23	£39.43
1200 x 1200	Oak	WSP12SWD	£67.50	£47.39

PRICE EACH

Size (mm)	Finishes	Code	1+
300 x 1200	Cream	WSP13C	£10.83
300 x 1200	White	WSP13W	£10.83
300 x 1200	Grey	WSP13G	£10.83
300 x 1200	Black	WSP13K	£11.27
300 x 1200	Oak	WSP13WD	£11.27

PRICE EACH

Available in five finishes:

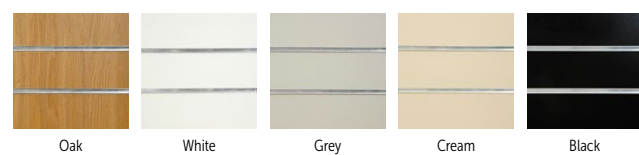

WSPi SLATWALL INSERTS

- Slatwall Inserts designed for use with our slatwall panels (WSP)
- PVC or aluminium inserts available in a choice of two lengths
- Strengthens panel grooves and adds protection to slatwall
- Four different finishes to choose from to suit your store design

Size (mm)	Finishes	Code	1+
300	White	WSPi02W	£0.32
300	Cream	WSPi02C	£0.32
300	Grey	WSPi02G	£0.32
300	Black	WSPi02K	£0.32
300	Aluminium	WSPi02AL	£0.90
1200	White	WSPi01W	£1.06
1200	Cream	WSPi01C	£1.06
1200	Grey	WSPi01G	£1.06
1200	Black	WSPi01K	£1.06
1200	Aluminium	WSPi01AL	£2.50

PRICE EACH



RSS SLATWALL SHELVING WITH BRACKETS

- Slatwall shelving supplied with chrome brackets
- Can be used universally with slatwall panels
- Made from 18mm thick MDF material with melamine finish
- Available in five different finishes
- Dimensions: 600mm W x 300mm D

Finishes	Code	1+	4+
Oak	RSS01WD	£18.19	£16.51
White	RSS01W	£16.15	£14.46
Grey	RSS01G	£16.15	£14.46
Cream	RSS01C	£16.15	£14.46
Black	RSS01K	£16.15	£14.46

PRICE EACH

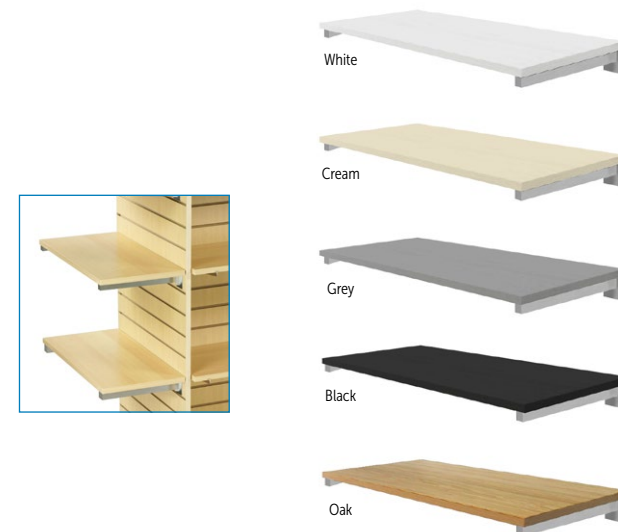

Complete your display with our wide collection of essential **slatwall accessories**, including hooks, shelves and trays.

For our full range of slatwall accessories visit [www.ukpos.com](http://www.ukpos.com)





**SPHA ACRYLIC SLATWALL TICKET HOLDER**

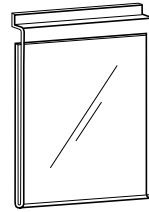

SPHAP – portrait

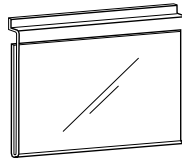

SPHAL – landscape

- Single-sided poster holder for simple slatwall displays
- Utilise all of your wall space effectively
- The top panel slots directly into your slatwall
- Manufactured from 2mm clear acrylic

**SPHAP – portrait**

Size	Code	1+	25+	100+	500+
A6	SPHAP-A6	£1.80	£1.70	£1.46	£1.28
A5	SPHAP-A5	£2.41	£2.21	£2.15	£1.95
A4	SPHAP-A4	£3.45	£3.21	£2.99	£2.70
A3	SPHAP-A3	£6.54	£5.74	£5.30	£4.92

PRICE EACH – Other sizes manufactured on request.

**SPHAL – landscape**

Size	Code	1+	25+	100+	500+
A7	SPHAL-A7	£1.48	£1.35	£1.23	£1.08
A6	SPHAL-A6	£1.85	£1.73	£1.48	£1.30
A5	SPHAL-A5	£2.44	£2.26	£2.17	£1.93
A4	SPHAL-A4	£3.50	£3.28	£3.05	£2.81
A3	SPHAL-A3	£6.78	£5.94	£5.14	£4.92

PRICE EACH – Other sizes manufactured on request.

**SPHPP BUDGET SLATWALL TICKET HOLDER**

BUDGET

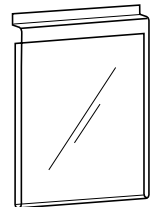

- Flexible poster holder for simple slatwall displays
- Utilise all of your wall space effectively
- Top panel slots into slatwall
- Manufactured in 1000 micron clear PVC

**Portrait**

Size	Code	1+	25+	100+	500+
A5	SPHPP-A5	£1.63	£1.38	£1.27	£1.14
A4	SPHPP-A4	£2.34	£1.95	£1.82	£1.72

PRICE EACH – Other sizes manufactured on request.

For our full range of slatwall accessories visit [www.ukpos.com](http://www.ukpos.com)



**FFS SINGLE PRONG SLATWALL HOOK**

- Single Prong Slatwall Hook for hanging smaller products
- Free up valuable shelf space with merchandising hooks
- Designed for use with slatwall displays
- Manufactured from chrome-plated aluminium with a black rubber end cap



Length (mm)	Code	10+	100+	500+
100	FFS-100	£0.37	£0.30	£0.28
150	FFS-150	£0.39	£0.32	£0.29
200	FFS-200	£0.42	£0.35	£0.32
250	FFS-250	£0.47	£0.37	£0.35

MINIMUM 10/PRICE EACH

**FFD DOUBLE PRONG SLATWALL HOOK**

- Double prong display hook for hanging smaller products
- Free up valuable shelf space with merchandising hooks
- Designed for use with slatwalls
- Manufactured from chrome-plated aluminium



Length (mm)	Code	10+	100+	500+
100	FFD-100	£0.76	£0.55	£0.51
150	FFD-150	£0.80	£0.62	£0.53
200	FFD-200	£0.91	£0.75	£0.65
300	FFD-300	£1.10	£0.99	£0.94

MINIMUM 10/PRICE EACH

**OMP LOOPED HOOK WITH OVERARM TICKET HOLDER**

- Looped display hook with a built-in ticket holder
- Ideal for displaying smaller hanging items
- Display prices or barcodes in the overarm holder
- 3.5mm diameter polished zinc wire
- Ticket holder size: 80mm W x 39mm H
- Suitable for use with euro hook product hanging tabs



Length (mm)	Code	10+	100+	500+
100	OMP-100	£0.94	£0.77	£0.69
150	OMP-150	£1.07	£0.89	£0.80
200	OMP-200	£1.21	£0.98	£0.88
300	OMP-300	£1.46	£1.19	£1.05

MINIMUM 10/PRICE EACH

**OFD DOUBLE PRONG SLATWALL HOOK WITH OVERARM TICKET HOLDER**

- Looped display hook designed for slatwall use
- Conveniently display prices or barcodes in the in-built overarm holder
- 4.88mm diameter chrome-plated wire
- Ticket holder size: 80mm W x 39mm H
- Ticket holder flips up for easy access to items



Length (mm)	Code	10+	100+	500+
100	OFD-100	£1.03	£0.78	£0.74
150	OFD-150	£1.05	£0.83	£0.80
200	OFD-200	£1.17	£0.94	£0.88
300	OFD-300	£1.32	£1.05	£0.99

MINIMUM 10/PRICE EACH

**FMP-S SINGLE PRONG PEG METAL HOOK**

- Single Prong Hook designed for use on pegboards
- 25mm spacing will suit most pegboards
- Manufactured from 4mm polished zinc wire with black rubber end cap



Length (mm)	Code	10+	100+	500+
100	FMP-S100	£0.36	£0.27	£0.25
150	FMP-S150	£0.44	£0.36	£0.34
200	FMP-S200	£0.49	£0.39	£0.36

MINIMUM 10/PRICE EACH – Other colours available on request.

**FMP-D LOOPED PEG METAL HOOK**

- Looped hook designed for use on pegboards
- 25mm spacing will suit most pegboards
- Manufactured from 3.5mm diameter polished zinc wire



Length (mm)	Code	10+	100+	500+
100	FMP-D100	£0.35	£0.30	£0.29
150	FMP-D150	£0.37	£0.32	£0.31
200	FMP-D200	£0.39	£0.33	£0.32

MINIMUM 10/PRICE EACH – Other colours available on request.



**PRQ MERCHANDISING HOOK LABEL HOLDER**



Double prong hook

Single prong hook

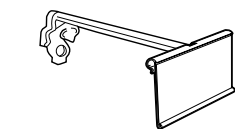

Clips onto both single and double-pronged hooks

- Hinged front label holder ideal for prices or barcodes
- Designed for use with single or double-prong merchandising hooks
- Ticket holder is white with a clear front
- Ticket holder size: 80mm W x 39mm H

Length (mm)	Code	10+	100+	250+	500+
150	PRQ150	£1.06	£0.91	£0.81	£0.76
200	PRQ200	£1.07	£0.89	£0.82	£0.77
250	PRQ250	£1.15	£0.92	£0.83	£0.78
300	PRQ300	£1.16	£0.95	£0.89	£0.82

MINIMUM 10/PRICE EACH – Other sizes available on request.

**EOA REFLEX™ GRAPHIC HOLDER**

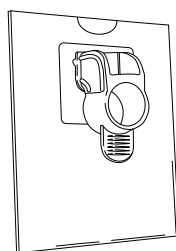

- Reflex™ graphic holder for use with nearly all retail rails
- Easy to fit, flexible and re-usable tool for price or offers
- Will work with 98% of rails and will stretch to fit most designs
- Manufactured from clear silicone rubber
- Available in various sizes to suit your tickets

Size (mm)	Code	1+	25+	100+
100 x 100	EOA10	£4.51	£3.90	£3.70
A7P	EOA2	£4.95	£4.20	£3.90
A6P	EOA3	£5.50	£4.80	£4.50

PRICE EACH



**ST3 CLEAR POCKET SWING TAG**

- Clear plastic swing tags with a pocket-style insert
- Ideal for displaying prices or barcodes
- Designed for use on merchandising hooks
- Available to suit either 4.8mm or 6mm diameter wire
- Available in two different sizes to suit price tickets

Ticket size 25 x 27mm

PRICE PER PACK OF 100				
Wire diameter	Code	1+	5+	10+
4.8mm	ST3-27	£5.47	£4.46	£3.90
6mm	ST3-25-6	£8.03	£6.60	£6.27

Ticket size 25 x 38mm

PRICE PER PACK OF 100				
Wire diameter	Code	1+	5+	10+
4.8mm	ST3-38	£5.94	£4.61	£3.95
6mm	ST3-38-6	£8.14	£6.70	£6.37



**ST2 WHITE LOCKING SWING TAG**

- Swing tags with a pocket-style insert
- Ideal for prices or barcodes
- Designed for use on double-prong hooks
- Various sizes to suit wire 4mm, 4.8mm or 6mm in diameter
- Manufactured from white UPVC
- Supplied in packs of 100

Ticket size 25 x 27mm

PRICE PER PACK OF 100				
Wire diameter	Code	1+	5+	10+
4.8mm	ST2W-25-48	£5.39	£4.50	£4.00

Ticket size 25 x 38mm

PRICE PER PACK OF 100				
Wire diameter	Code	1+	5+	10+
4.8mm	ST2W-38-48	£5.72	£4.90	£4.60
6mm	ST2W-38-6	£5.72	£4.90	£4.60



Ticket size 25 x 25mm

PRICE PER PACK OF 100				
Wire diameter	Code	1+	5+	10+
4mm	ST2	£4.50	£3.90	£3.70



**P21 ADHESIVE HANG TAB PADS**

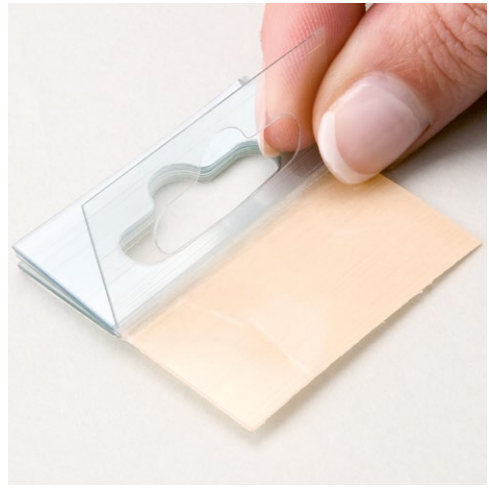

PRICE PER BOX OF 500		
Code	1+	10+
P21	£14.85	£11.80



- Adhesive hang tabs for hanging products on hooks
- Ideal for packets and boxes
- Overall size: 50mm W x 50mm H
- Thickness: 380 micron PVC
- Sold in boxes of 500

**R1000 HANG TABS REEL**



- Adhesive hang tabs for hanging products on hooks
- Ideal for packets and boxes
- Overall size: 50mm W x 50mm H
- R1000 thickness: 250 micron
- R1001 thickness: 380 micron
- Reel of 1000

PRICE PER REEL OF 1000		
Code	1+	10+
R1000	£26.00	£22.20
R1001	£30.25	£26.21

**EHT CARDBOARD HANG TABS X 1000**

**NEW**



EHTS-36



EHTS-1000

- 100% plastic-free hang tabs provide a recyclable merchandising solution
- Eco-friendly retail solution manufactured in the UK
- Available either on a roll of 1000 tabs, or 28 sheets of 36 tabs (1008)
- With an adhesive backing to quickly apply to your products

PRICE PER SHEETS OF 1008			
Size (mm)	Code	1+	10+
40 W x 30 H	EHTS-36	£26.00	£22.50

PRICE PER ROLL OF 1000			
Size (mm)	Code	1+	10+
50 W x 50 H	EHTR-1000	£35.00	£32.00

**MS10 PLASTIC CLIP STRIPS**



- Plastic clip strip ideal for retailers and supermarkets
- A simple way to upsell from your shelves
- Designed with 12 evenly-spaced stations
- Includes a header for applying your prices or barcodes
- Made from translucent polypropylene
- Overall length: 620mm
- Header size: 76mm W x 35mm H
- Supplied in packs of 100

PRICE PER PACK OF 100			
Code	1+	5+	10+
MS10	£24.00	£23.00	£21.80



**MS2 PLASTIC HANG STRIPS**

- Plastic hang strip for use on supermarket or retail shelving
- Increase impulse buys with well-placed clip strips
- Designed with 12 evenly-spaced stations
- MS20 includes a ticket facility
- MS21 does not include a ticket facility
- Supplied in packs of 100

PRICE PER PACK OF 100			
Code	1+	5+	10+
MS21	£25.00	£23.00	£21.00
MS20	£30.58	£27.80	£25.48



FROM **£21.00**

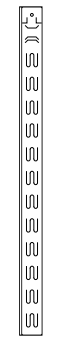

MS20

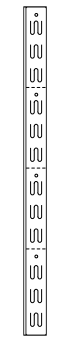

MS21





## MHH MINI MAGNETIC CEILING LOOP



- Round magnet with a 6mm diameter closed loop
- Ideal for suspending lightweight POS displays
- Designed with a powerful neodymium magnet with a 2kg pull force
- Manufactured from clear polycarbonate
- Supplied in packs of 100

PRICE PER PACK OF 100			
Code	1+	5+	10+
MH3	£39.50	£36.00	£31.50

## MH1 MAGNETIC CEILING HOOK

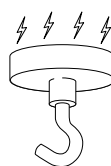

- Round magnet for suspending POS from ceilings
- MH1-32 and MH1-47 hook pull force is 6kg, tested on 10mm polished steel at room temperature
- MH1-63 Hook pull force is 30kg, tested on 10mm polished steel at room temperature
- Manufactured with white metal casing

Base	Code	1+	25+	100+
32mm	MH1-32	£0.85	£0.71	£0.62
47mm	MH1-47	£1.28	£1.03	£0.92
63mm	MH1-63	£2.18	£2.03	£1.93

MINIMUM 10/PRICE EACH

## HB1 ROUND HANGING BUTTONS



FROM  
**£2.39**

- Hanging buttons for ceiling displays
- Designed with an adhesive foam base
- Diameter: 20mm
- Supplied in packs of 100

PRICE PER PACK OF 100				
Colour	Code	1+	5+	10+
White	HB1	£3.60	£2.79	£2.39
Clear	HB5	£3.95	£3.20	£2.60

## DHW1 DOUBLE HOOK SUSPENSION WIRE

- Suspension wire for striking ceiling displays
- Manufactured from 2mm galvanised wire
- Featuring a hook at each end
- Supplied in packs of 100

FROM  
**£1.93**

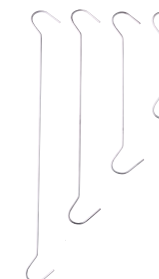

PRICE PER PACK OF 100				
Size	Code	1+	5+	10+
100mm (4")	DHW1-4	£2.18	£2.03	£1.93
150mm (6")	DHW1-6	£3.69	£2.89	£2.59
200mm (8")	DHW1-8	£3.95	£3.09	£2.79
250mm (10")	DHW1-10	£4.35	£3.79	£3.05
300mm (12")	DHW1-12	£4.19	£3.78	£3.05
400mm (16")	DHW1-16	£6.60	£5.50	£4.90
508mm (20")	DHW1-20	£7.10	£5.90	£5.00



## EWH1 EXTENDING WIRE HOOKS

- Extending wire hooks for suspending posters from ceilings
- Pull to the desired length and they remain in position
- EWH1-160: 160mm extending to 1000mm
- EWH1-210: 210mm extending to 1500mm
- Supplied in packs of 100



PRICE PER PACK OF 100			
Code	1+	5+	10+
EWH1-160	£4.09	£3.85	£3.15
EWH1-210	£5.79	£5.50	£4.35



Over 25 million stocked items available for next day delivery

All of our stock in our extensive UK-based warehouse is available for next day delivery.

To speak to our sales team  
**CALL 0161 516 2467**



## STS1 STUD SUCTION CUP



- Ideal for attaching products or panels to windows
- Eliminates the need for adhesive or fixing holes
- Manufactured from tough clear PVC
- Available in three diameters: 20mm, 30mm or 40mm
- Supplied in packs of 100 (Poster holder not included)

FROM  
**£2.65**

PRICE PER PACK OF 100				
Size diameter (mm)	Code	1+	5+	10+
20	STS1-20	£3.28	£2.67	£2.65
30	STS1-28	£7.81	£5.90	£5.67
40	STS1-40	£10.78	£9.10	£8.50

## HS1 SUCTION CUPS WITH HOOK

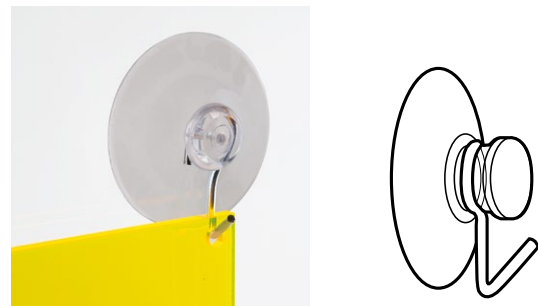

- Suction cup with a small metal hook for hanging displays
- Easy application requires no adhesive
- Manufactured from clear PVC
- Diameter: 40mm
- Supplied in packs of 100

PRICE PER PACK OF 100			
Code	1+	5+	10+
HS1	£11.89	£9.30	£9.15

## TS1 THUMB TACK SUCTION CUP

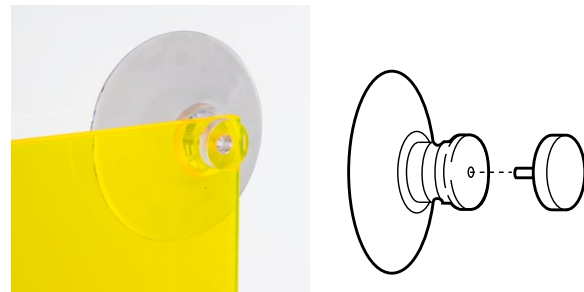

- Suction cup with a removable tack
- Ideal for securing displays to windows
- Manufactured from clear PVC
- Supplied in packs of 100

PRICE PER PACK OF 100				
Size (mm)	Code	1+	5+	10+
20	TS1-20	£9.88	£8.10	£7.90
40	TS1-40	£11.50	£9.95	£9.20

## MSS METAL SPLIT RINGS



- Split rings with a locking mechanism
- Ideal for attaching or connecting POS displays
- Manufactured from nickel-plated metal
- Available in four sizes (sizes shown are internal diameter)
- Supplied in packs of 100

PRICE PER PACK OF 100				
Size diameter (mm)	Code	1+	5+	10+
20	MSS-20	£6.39	£5.95	£4.78
25	MSS-25	£7.89	£7.20	£6.09
38	MSS-38	£9.29	£8.20	£6.39
50	MSS-50	£12.95	£11.55	£8.89

## 7005 MAGNETIC ADHESIVE TAPE 30M

- High-quality magnetic tape for connecting POS to metal surfaces
- Can easily be cut to your required length
- Tape has a pull strength of 55g per cm squared
- 15mm thick tape supplied in 30m rolls



Tape width	Code	1+	10+	100+
13mm	7005	£11.00	£8.10	£7.28

PRICE PER REEL

## 7004 ADHESIVE FOAM ROLL DOUBLE SIDED

- Double-sided adhesive foam tape for a permanent fixture
- Ideal for lightweight displays
- Available in 12mm and 20mm widths
- Supplied in 50m rolls

Size (mm)	Code	1+	10+	100+
12	7004-12	£7.70	£6.30	£5.50
20	7004-20	£17.60	£14.00	£13.00

PRICE PER REEL



## 7006 HOOK OR LOOP TAPE ROLL

- White tape roll with either hook or loop fasteners
- 20mm wide tape with adhesive backing
- Provides strong attachment and easy removal
- Supplied in 25m rolls

Size (mm)	Code	1+	10+	25+
20 x 25 hook	7006H	£6.49	£5.45	£4.85
20 x 25 loop	7006L	£6.49	£5.45	£4.85

PRICE PER REEL – Other thicknesses, widths and colours available.



## 7003 CLEAR PERMANENT TAPE DOUBLE SIDED

- Clear double-sided polyester tape
- Ideal for a variety of surfaces and displays
- Available in 10mm or 20mm widths
- Supplied in 50m rolls

Width (mm)	Code	1+	10+	100+
10	7003-12	£7.59	£4.50	£4.00
20	7003-20	£12.65	£7.60	£7.00

PRICE PER REEL



## 7007 VHB TAPE

- Very high bond tape for a secure lasting display
- Manufactured from clear acrylic
- 12mm width, 1mm thick
- Supplied in 33m rolls

Size (mm)	Code	1+	10+	100+
12	7007-12	£21.78	£17.00	£14.00

PRICE PER REEL







### CRB TRANSPARENT PROTECTIVE SCREEN ROLLER BANNER



Pull up banner base



Comes with a carry bag for easy storage and transportation

- Transparent roller banner that forms a protective screen
- Help protect customers and staff from the spread of infection
- The fastest and cheapest way to create a large protective screen
- Available in two widths and with the option to add custom branding

Size (mm)	Code	1+	10+
800 W x 2000 H	CRB800	£45.39	£42.30
1000 W x 2000 H	CRB1000	£64.35	£59.86

PRICE EACH

### Disposable Face Masks, Respirators and Face Shields

Help prevent the spread of infection between staff and customers with face coverings. Our face shields come with optional branding so you can add your company logo or message. This allows you to increase your brand recognition while protecting your staff and customers.

Visit [www.ukpos.com](http://www.ukpos.com) to find out more details



FACE-M Disposable Face Masks x50



FACE-F FFP2 Face Mask Respirator



FACE-S Face Shields (brandable)



FACE-G Face Shield with Glasses Frame



For our full range of hygiene screens visit [www.ukpos.com](http://www.ukpos.com)



FROM  
**£46.53**

### SNZ06 CHECKOUT SNEEZE GUARD WITH WINDOW

- Freestanding Checkout Sneeze Guard with clear PETG window
- Help keep staff and customers safer at tills and reception desks
- Lightweight flat-packed design for easy transportation
- Made from sturdy lightweight Foamex
- No tools required
- Custom branding available

Size (mm)	Code	1+
600 W x 750 H x 250 D	SNZ06-60	£46.53
1000 W x 750 H x 250 D	SNZ06-100	£53.44

PRICE EACH



### SNZ01 FLAT PACK SNEEZE SCREEN

- Low-cost sneeze screen supplied as a flat-pack kit
- Rounded edges for extra safety
- Freestanding or fixed-base design with a central payment hatch
- Custom branding available

Size (mm)	Code	1+
650 W x 800 H	SNZ01-65	£76.68
900 W x 750 H	SNZ01-90	£85.97

PRICE EACH





Unbranded HSS



No-touch automatic dispenser

### HSS TOUCH FREE HAND SANITISER DISPENSER STAND

- Freestanding no-touch hand sanitiser dispenser with robust steel construction
- Dispenses hand sanitiser with the use of a motion sensor
- Refillable and available to buy with 1 litre of hand sanitiser liquid
- Optional custom print for your branding or message
- Battery operated (4 x type AA batteries required)
- Overall size is 250mm W x 1500mm H x 400mm D
- Can hold 800ml of hand sanitiser liquid

#### Unbranded

Code	Colour	With hand sanitiser	1+
HSS03	Blue	No	£227.00
HSS03-LIQ	Blue	Yes	£235.90
HSS04	Grey	No	£227.00
HSS04-LIQ	Grey	Yes	£235.90

PRICE EACH

#### Custom-branded

Code	With hand sanitiser	1+
HSS03-BRANDED	No	£249.00
HSS03-LIQ-BRANDED	Yes	£261.90

PRICE EACH

### NSN1/NSN2 FREESTANDING HAND SANITISER DISPENSER

NEW

- Freestanding Hand Sanitiser Dispenser with an A4 snap frame
- Choose between a pump-action (1L capacity) and automatic dispenser (800ml capacity)
- Place at key points around your business to reduce the spread of infection
- Add an A4 'Clean Your Hands Here' poster if required
- Stand height: 1920mm, base size: 450mm x 450mm
- Pump-action dispenser size: 100mm W x 290mm H x 140mm D
- Automatic dispenser size: 275mm W x 115mm H x 110mm D
- Option to add a 1L bottle of liquid hand sanitiser available



Pump action dispenser



Automatic sensor dispenser



Automatic sensor dispenser NSN2

#### Pump action dispenser

With printed poster	Code	1+
No	NSN1-A4	£119.00
Yes	NSN1-A4-B	£122.78

PRICE EACH

#### Automatic sensor dispenser

With printed poster	Code	1+
No	NSN2-A4	£146.85
Yes	NSN2-A4-B	£150.63

PRICE EACH

### NSK1 FREESTANDING AUTOMATIC HAND SANITISER DISPENSER

NEW

- Freestanding hand sanitiser dispenser station with A4 poster holder to prevent the spread of infection
- No-touch design has clever sensors that dispense hand sanitiser without the need to touch the unit
- Add alcohol hand sanitiser liquid if required
- Optional 'Please Clean Your Hands Here' poster
- Refillable 800ml capacity with a 20cm sensor range
- 250mm W x 1100mm H (adjustable up to 1600mm) x 400mm D



Automatic sensor dispenser



Height adjustable



#### Automatic sensor dispenser

With sanitiser	With printed poster	Code	1+
No	No	NSK2-A4	£131.19
No	Yes	NSK2-A4-B	£134.97
Yes	No	NSK2-A4-LIQ	£143.69
Yes	Yes	NSK2-A4-LIQ-B	£147.47

PRICE EACH

### Wall Mounted Hand Sanitisers

Wall mounted hand sanitiser dispensers are a great way to promote hygiene and help reduce the spread of infection in premises where floor space is limited. To learn more about our full range, visit [www.ukpos.com](http://www.ukpos.com) or call **0161 516 2467**



WSN



WSK1



# Bespoke manufacturing

Our bespoke service allows us to manufacture goods to your exact specification and can include artwork to promote your products or organisation.

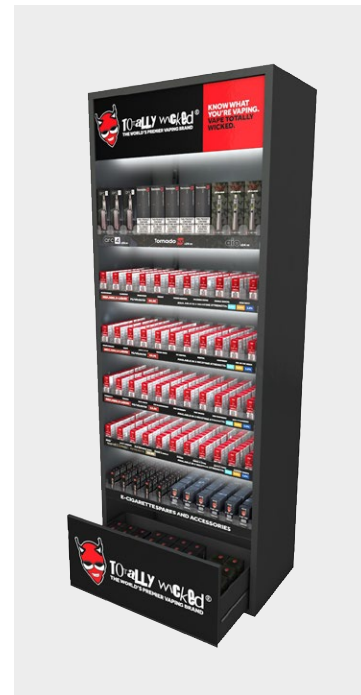

Our team can create virtually any product for manufacture and can give guidance and support on changes to existing products.

We are constantly developing bespoke products on a global level, ensuring that our customers receive the best service and products available within the industry.

Our highly skilled conceptual designers will work with you and your budget to create a comprehensive display solution to exceed your needs and expectations.

From concept to completion, our team will guide you through the bespoke process.

To speak to our sales team call **0161 516 2467**



## Print service

We boast an extensive in-house printing service which allows you to order your completed POS display in one go.

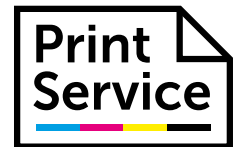

This service complements our snap frames, pavement signs, promotional stands, café barrier systems and roller banners, which can all be completed with the accompanying poster or banner.

## Design service



If you are purchasing one of our printed or branded products, but do not have a professional designer available to create the required artwork templates, you may consider adding our Branding And Print Design Service to your order.

Our in-house team can use any logos, images and text you send us to create a finished piece of artwork that is effective and ready to print.



Visit [www.ukpos.com](http://www.ukpos.com) for more information



# UK manufacturers

Our 60,000 sq ft manufacturing HQ in Greater Manchester uses world-leading manufacturing technology for a range of materials, including plastic, metal and wood.

Manufacturing our own products means that our customers get high-quality products at low prices. We manage every step of the process so you know your products are made with precision and care.

We have over 25 million products ready for same day despatch if you order by 5pm, and they can be with you the next day.



# Green thinking

At UK POS we are continually evaluating our environmental impact. We are committed to working with our partners and consumers to create a greener and more sustainable planet. We have ISO-accredited quality management systems in place to ensure we are always reviewing and improving our environmental practices.

We always encourage our customers to reuse or recycle our acrylic and wooden products when the products are no longer in use or needed.

As well as manufacturing responsibly, we like to offer products that help our customers make more eco-conscious choices. Our range of zero waste dispensers encourage shoppers to reduce excess waste.

# Best sellers

The best selling POS display items are all designed to make your business more attractive, functional, professional and easy to navigate.



ABC4 pg 57



AS1 pg 5

“ Increase footfall and maximise sales with strategic POS displays ”

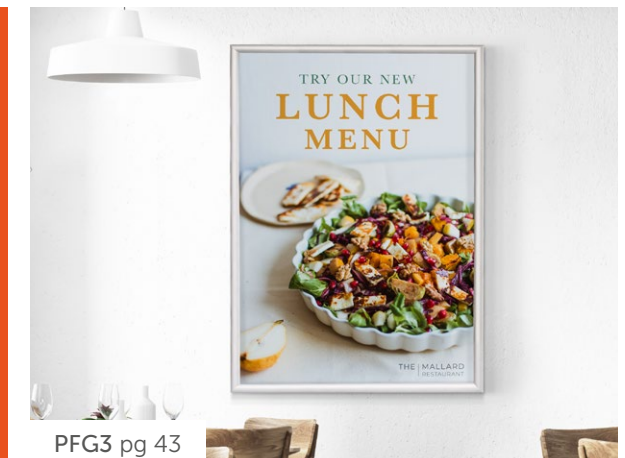

PFG3 pg 43



CD3 pg 71

Ensure your POS is on-trend to keep your display fresh and your customers interested.

Updating your POS is a great way to maximise your selling potential and boost profits.





**UK Point of Sale Group Ltd.**

Horsfield Way, Bredbury Park Industrial Estate,  
Stockport, Greater Manchester, SK6 2TD.

Visit: [www.ukpos.com](http://www.ukpos.com) Call: 0161 516 2467 Email: [sales@ukpos.com](mailto:sales@ukpos.com)

All purchases are subject to terms and conditions. Prices are correct at the time of publication and are subject to change. Please see website for up-to-date prices. © UK Point of Sale Group Ltd 2021. All information contained in this brochure, whether in text, drawing, photographic form or otherwise, is copyright of UK Point of Sale Group Ltd, and may not be reproduced in whole or in part without the express permission of the company in writing. UK Point of Sale Group Ltd will not hesitate to commence legal action if necessary.

